

# CESSNA

MORE PEOPLE BUY AND  
FLY CESSNA AIRPLANES  
THAN ANY OTHER MAKE

## 1973

WORLD'S LARGEST PRO-  
DUCER OF GENERAL  
AVIATION AIRCRAFT  
SINCE 1956

# MODEL 310Q



## OWNER'S MANUAL

# PERFORMANCE AND SPECIFICATIONS

<b>GROSS WEIGHT:</b>		
Takeoff		5300 lbs.
Landing		5300 lbs.
<b>SPEED BEST POWER MIXTURE:</b>		
Maximum - Sea Level		236 mph.
Maximum Recommended Cruise		
75% Power at 6500 ft.		221 mph.
<b>RANGE, RECOMMENDED LEAN MIXTURE:</b>		
Maximum Recommended Cruise		
75% Power at 6500 ft.		774 mi.
600 lbs. . No Reserve		3.55 hrs.
75% Power at 6500 ft.		218 mph.
978 lbs. . No Reserve		1258 mi.
		5.77 hrs.
75% Power at 6500 ft.		218 mph.
1218 lbs. . No Reserve		1565 mi.
		7.18 hrs.
		218 mph.
Maximum Range		
10,000 ft. . 600 lbs. . No Reserve		960 mi.
		5.25 hrs.
		183 mph.
10,000 ft. . 978 lbs. . No Reserve		1566 mi.
		8.56 hrs.
		183 mph.
10,000 ft. . 1218 lbs. . No Reserve		1550 mi.
		10.66 hrs.
		183 mph.
<b>RATE OF CLIMB AT SEA LEVEL:</b>		
Twin Engine		1495 fpm.
Single Engine		327 fpm.
<b>SERVICE CEILING:</b>		
Twin Engine		19,500 ft.
*Single Engine		6680 ft.
<b>TAKEOFF PERFORMANCE: Takeoff Speed (90 MPH IAS 15° Flaps)</b>		
Ground Run		1519 ft.
Total Distance Over 50-foot Obstacle		1795 ft.
<b>LANDING PERFORMANCE: Approach Speed (103 MPH IAS, 5300 lbs.)</b>		
Ground Roll		582 ft.
Total Distance Over 50-foot Obstacle		1697 ft.
<b>EMPTY WEIGHT: (Approximate)</b>		3214 lbs.
<b>BAGGAGE ALLOWANCE:</b>		600 lbs.
<b>WING LOADING</b>		29.6 lbs./sq. ft.
<b>POWER LOADING:</b>		10.2 lbs./hp.
<b>FUEL CAPACITY: TOTAL</b>		
Standard		102 gals.
With Auxiliary Tanks (40 gal. usable)		143 gals.
With Auxiliary Tanks (63 gal. usable)		166 gals.
With Auxiliary Tanks (63 gal. usable) and Wing Locker Tanks		207 gals.
<b>OIL CAPACITY: TOTAL</b>		6.0 gals.
<b>ENGINES:</b>		
Continental 6-Cylinder,		
Fuel Injection Engines		IO-470-VO
260 Rated HP at 2625 RPM		
<b>PROPELLERS:</b>		
Constant Speed, Full Feathering, Two Bladed		
81" Diameter		D2AF34C71-L1/84JF-3

\*Single engine service ceiling increases 425 feet for each 30 minutes of flight.

# CONGRATULATIONS.....

Welcome to the ranks of Cessna owners! Your Cessna has been designed and constructed to give you the most in performance, economy, and comfort. It is our desire that you will find flying it, either for business or pleasure, a pleasant and profitable experience.

This Owner's Manual has been prepared as a guide to help you get the most pleasure and utility from your aircraft. It contains information about your Cessna's equipment, operating procedures, and performance; and suggestions for its servicing and care. We urge you to read it from cover to cover, and to refer to it frequently.

Our interest in your flying pleasure has not ceased with your purchase of a Cessna. Worldwide the Cessna Dealer Organization backed by the Cessna Service Department stands ready to serve you. The following services are offered by most Cessna Dealers:

**THE CESSNA WARRANTY** -- it is designed to provide you with the most comprehensive coverage possible:

- a. No exclusions
- b. Coverage includes parts and labor
- c. Available at Cessna Dealers worldwide
- d. Best in the industry

Specific benefits and provisions of the warranty plus other important benefits for you are contained in your Customer Care Program booklet supplied with your aircraft. Warranty service is available to you at any authorized Cessna Dealer throughout the world upon presentation of your Customer Care Card which establishes your eligibility under the warranty.

**FACTORY TRAINED PERSONNEL** to provide you with courteous expert service.

**FACTORY APPROVED SERVICE EQUIPMENT** to provide you with the most efficient and accurate workmanship possible.

**A STOCK OF GENUINE CESSNA SERVICE PARTS** on hand when you need them.

**THE LATEST AUTHORITATIVE INFORMATION FOR SERVICING CESSNA AIRCRAFT**, since Cessna Dealers have all of the Service Manuals and Parts Catalogs, kept current by Service Letters and Service News Letters, published by Cessna Aircraft Company.

We urge all Cessna owners to use the Cessna Dealer Organization to the fullest.

A current Cessna Dealer Directory accompanies your new aircraft. The Directory is revised frequently, and a current copy can be obtained from your Cessna Dealer. Make your Directory one of your cross-country flight planning aids; a warm welcome awaits you at every Cessna Dealer.

\* Maximum height of aircraft with nose gear depressed is 10'-8 3/4", if rotating beacon is installed, add 3" to maximum height.

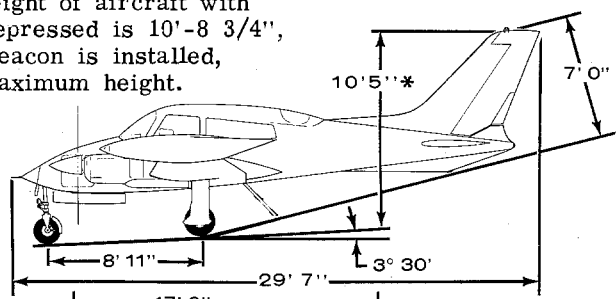

**PRINCIPAL DIMENSIONS**

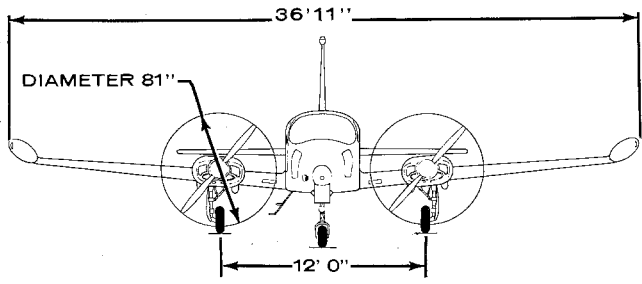
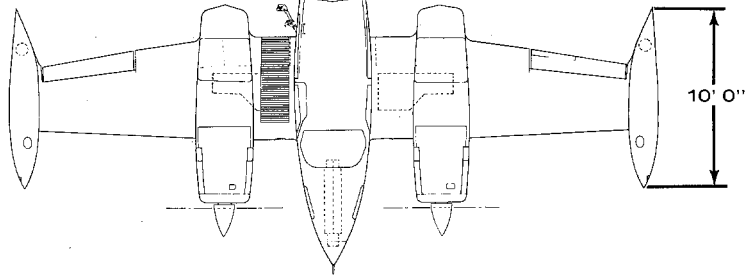
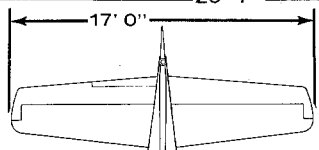

# TABLE OF CONTENTS

310

	Page
SECTION I - OPERATING CHECKLIST .....	1-1
SECTION II - DESCRIPTION AND OPERATING DETAILS .....	2-1
SECTION III - EMERGENCY PROCEDURES .....	3-1
SECTION IV - OPERATING LIMITATIONS .....	4-1
SECTION V - CARE OF THE AIRCRAFT .....	5-1
OWNER FOLLOW-UP SYSTEM .....	5-6
SECTION VI - OPERATIONAL DATA .....	6-1
SECTION VII - OPTIONAL SYSTEMS .....	7-1
ALPHABETICAL INDEX .....	Index - 1

## INSTRUMENT PANEL

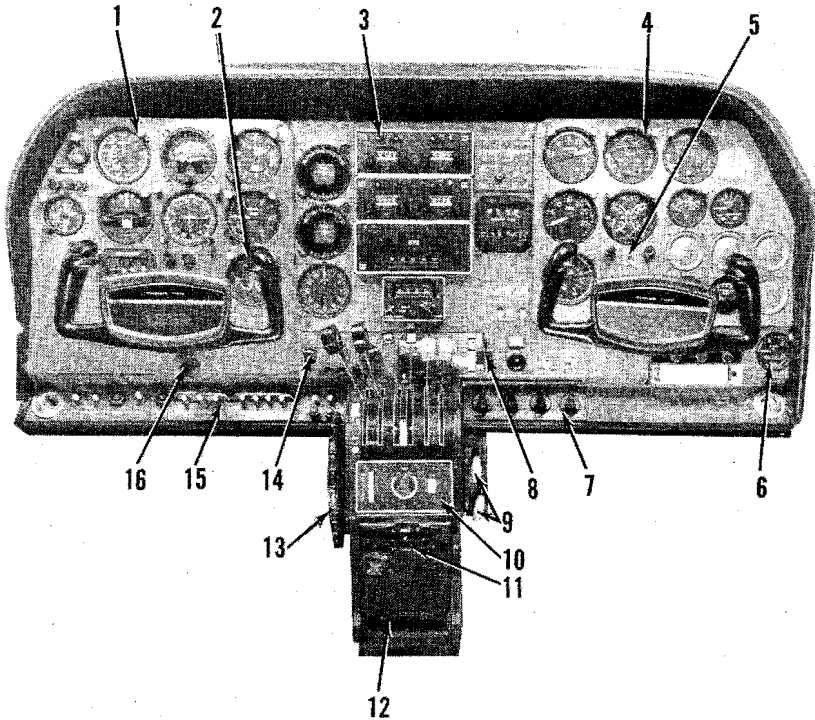

- |  |                                      |
|--|--------------------------------------|
| 1 FLIGHT INSTRUMENT GROUP                  | 8 FLAP POSITION SWITCH               |
| 2 ECONOMY MIXTURE INDICATOR (OPTIONAL)     | 9 ALTERNATE AIR CONTROLS             |
| 3 AVIONICS CONTROL PANEL (OPTIONAL)        | 10 AUTOPILOT CONTROL HEAD (OPTIONAL) |
| 4 ENGINE INSTRUMENT GROUP                  | 11 RUDDER TRIM CONTROL               |
| 5 FUEL QUANTITY SELECTOR SWITCH (OPTIONAL) | 12 AILERON TRIM CONTROL              |
| 6 OXYGEN CYLINDER PRESSURE GAGE (OPTIONAL) | 13 ELEVATOR TRIM CONTROL             |
| 7 HEATER AND CABIN AIR CONTROL PANEL       | 14 LANDING GEAR POSITION SWITCH      |
|  | 15 LEFT-HAND SWITCH PANEL            |
|  | 16 OXYGEN CONTROL KNOB (OPTIONAL)    |

---

One of the first steps in obtaining the utmost performance, service, and flying enjoyment from your Cessna is to familiarize yourself with your aircraft's equipment, systems, and controls. This can best be done by reviewing this equipment while sitting in the aircraft. Those items whose function and operation are not obvious are covered in Section II.

Section I lists, in Pilot's Checklist form, the steps necessary to operate your aircraft efficiently and safely. It covers briefly all the points that you should know concerning the information you need for a typical flight.

The flight and operational characteristics of your aircraft are normal in all respects. All controls respond in the normal way within the entire range of operation.

**MAKE A PREFLIGHT INSPECTION IN ACCORDANCE WITH FIGURE 1-1.**

## **BEFORE STARTING THE ENGINES**

- (1) Preflight Inspection - COMPLETE.
- (2) Control Lock(s) - REMOVE.
- (3) Seats, Seat Belts and Shoulder Harness - ADJUST and SECURE.
- (4) Brakes - TEST and SET.
- (5) Landing Gear Switch - DOWN.
- (6) Emergency Alternator Field Switch - OFF.
- (7) Circuit Breakers - IN.
- (8) All Switches - OFF.
- (9) Battery and Alternators - ON.

# PREFLIGHT INSPECTION

## NOTE

Visually check inspection plates and general aircraft condition during walk-around inspection. If night flight is planned, check operation of all lights and make sure a flashlight is available.

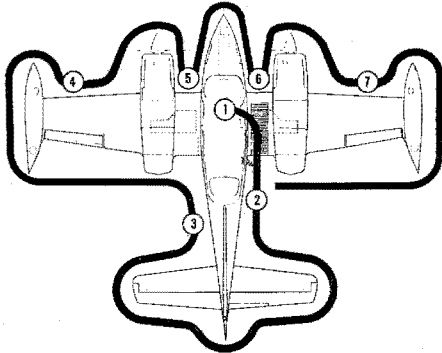

1

- a. Control Lock(s) - REMOVE and STOW.
- b. Parking Brake - SET.
- c. All Switches - OFF.
- d. All Circuit Breakers - IN.
- e. Landing Gear Switch - DOWN.
- f. Left Fuel Selector - LEFT MAIN (feel for detent).
- g. Right Fuel Selector - RIGHT MAIN (feel for detent).
- h. Trim Tab Controls (3) - NEUTRAL.
- i. Oxygen - CHECK quantity, masks, and hoses - OFF.
- j. Battery Switch - ON.
- k. Fuel Gages - CHECK quantity and operation.
- l. Flaps - EXTEND.

2

- a. Baggage Door - SECURE.
- b. Static Port - CLEAR.
- c. Deice Boots - CHECK condition and security, if installed.
- d. Control Surface Locks - REMOVE, elevator and rudder.
- e. Elevators and Tab - Check condition, freedom of movement, and tab position.
- f. Tie Down - REMOVE.
- g. Rudder and Tab - CHECK condition, freedom of movement, and tab position.

3

- a. Static Port - CLEAR.
- b. Wing Locker Baggage Door - SECURE.
- c. Battery Compartment Cover - SECURE.
- d. Flap - CHECK security and attachment.
- e. Control Surface Lock - REMOVE.
- f. Aileron and Tab - CHECK condition, freedom of movement, and tab position.
- g. Tip Tank Transfer Pump - LISTEN for operation.
- h. Fuel Sump (Main Tank) - DRAIN.
- i. Fuel Vent and Sniffle Valve - CLEAR.
- j. Fuel Quantity (Main Tank) - CHECK, cap secure.
- k. Deice Boot - CHECK condition and security, if installed.
- l. Stall Warning Vane - CHECK freedom of movement and audible warning.
- m. Wing Tie Down - REMOVE.

Figure 1-1 (Sheet 1 of 2)



- 4
- a. Fuel Quantity (Auxiliary Tank) - CHECK, cap secure.
  - b. Fuel Vent (Wing Locker Tank) - CLEAR, if installed.
  - c. Fuel Sump (Auxiliary Tank and Wing Locker Transfer Line, if installed) - DRAIN.
  - d. Fuel Strainer - DRAIN.
  - e. Fuel Quantity (Wing Locker Tank) - CHECK, cap secure, if installed.
  - f. Oil Level - CHECK, minimum 9 quarts.
  - g. Engine Compartment General Condition - CHECK.
  - h. Propeller and Spinner - EXAMINE for nicks, security and oil leaks.
  - i. Leading Edge Air Intake - CLEAR.
  - j. Main Gear Strut, Doors and Tire - CHECK.
  - k. Fuel Sump (Wing Locker Tank) - DRAIN, if installed.
- 5
- a. Nose Access Panel - SECURE.
  - b. Nose Gear, Strut, Doors and Tire - CHECK.
  - c. Pitot Cover - REMOVE, if installed.
  - d. Pitot Tube - CLEAR.
  - e. Tie Down - REMOVE.
  - f. Heater Inlet - CLEAR.
  - g. Nose Access Panel - SECURE.
- 6
- a. Leading Edge Air Intake - CLEAR.
  - b. Crossfeed Lines - DRAIN.
  - c. Fuel Sump (Wing Locker Tank) - DRAIN, if installed.
  - d. Main Gear, Strut, Doors and Tire - CHECK.
  - e. Fuel Quantity (Wing Locker Tank) - CHECK, cap secure, if installed.
  - f. Oil Level - CHECK, minimum 9 quarts.
  - g. Engine Compartment General Condition - CHECK.
  - h. Propeller and Spinner - EXAMINE for nicks, security and oil leaks.
  - i. Fuel Vent (Wing Locker Tank) - CLEAR, if installed.
  - j. Fuel Sump (Auxiliary Tank and Wing Locker Transfer Line, if installed) - DRAIN.
  - k. Fuel Strainer - DRAIN.
  - l. Fuel Quantity (Auxiliary Tank) - CHECK, cap secure.
- 7
- a. Wing Tie Down - REMOVE.
  - b. Deice Boot - CHECK condition and security, if installed.
  - c. Fuel Quantity (Main Tank) - CHECK, cap secure.
  - d. Fuel Vent and Sniffle Valve - CLEAR.
  - e. Fuel Sump (Main Tank) - DRAIN.
  - f. Tip Tank Transfer Pump - LISTEN for operation.
  - g. Control Surface Lock - REMOVE.
  - h. Aileron - CHECK condition and freedom of movement.
  - i. Flap - CHECK security and attachment.
  - j. Wing Locker Baggage Door - SECURE.
  - k. Battery Switch - OFF.

Figure 1-1 (Sheet 2 of 2)

### NOTE

When using an external power source, do not turn on battery or alternator switches until external power is disconnected, to avoid damage to the alternators and a weak battery draining off part of the current being supplied by the external source.

- (10) Lighting Rheostats - AS REQUIRED.
- (11) Altimeter and Clock - SET.
- (12) Heater Overheat and T & B - PRESS-TO-TEST.
- (13) Landing Gear Position Indicator Lights - CHECK (press to test as required).
- (14) Cabin Air Controls - AS REQUIRED.
- (15) Fuel Quantity - CHECK.
- (16) All Radio Switches - OFF.
- (17) Throttles - Open one inch.
- (18) Propellers - FULL FORWARD.
- (19) Mixtures - FULL RICH.
- (20) Fuel Selectors - Left Engine - LEFT MAIN (feel for detent).  
Right Engine - RIGHT MAIN (feel for detent).
- (21) Alternate Air Controls - IN.

## STARTING ENGINES (Left Engine First)

### NORMAL START (NO EXTERNAL POWER)

- (1) Propeller - CLEAR.
- (2) Magneto Switches - ON.
- (3) Engine - START.
  - (a) Starter Button - PRESS.
  - (b) Primer Switch - Left Engine - LEFT  
Right Engine - RIGHT.

## CAUTION

- If the primer switch is activated for excessive periods of time with the engine inoperative on the ground or during flight, damage may be incurred to the engine and/or aircraft due to fuel accumulation in the induction system. Similar conditions may develop when the engine is shut-down with the auxiliary pump switch in the ON position.
- During very hot weather, caution should be exercised to prevent overpriming the engines.
- Should fuel priming or auxiliary pump operation periods in excess of 60 seconds occur, the engine manifold must be purged by one of the following procedures:
  - (a) With auxiliary fuel pump switch OFF, allow manifold to drain at least 5 minutes or until fuel ceases to flow out of the drain under the nacelle.
  - (b) If circumstances do not allow natural draining periods recommended above, with the auxiliary pump switch OFF, magneto switches OFF, mixture idle cut-off and throttle full open, turn engine with starter or by hand a minimum of 15 revolutions.

- (4) Auxiliary Fuel Pump - LOW (to purge vapor from fuel system).
- (5) Throttle - 1000 to 1200 RPM.
- (6) Oil Pressure - 10 PSI minimum in 30 seconds in normal weather or 60 seconds in cold weather. If no indication appears, shut-down engine and investigate.
- (7) Right Engine - START (repeat steps 1 through 6).
- (8) Alternators - CHECK.
- (9) Rotating Beacon - ON.
- (10) Radios - ON.
- (11) Flaps - RETRACT.

## STARTING ENGINES (Left Engine First)

### WITH EXTERNAL POWER SOURCE

- (1) Battery and Alternator Switches - OFF.
- (2) External Power Source - PLUG IN.
- (3) Propeller - CLEAR.
- (4) Magneto Switches - ON.
- (5) Engine - START.
  - (a) Starter Button - PRESS.
  - (b) Primer Switch - Left Engine - LEFT.  
Right Engine - RIGHT.

#### CAUTION

- If the primer switch is activated for excessive periods of time with the engine inoperative on the ground or during flight, damage may be incurred to the engine and/or aircraft due to fuel accumulation in the induction system. Similar conditions may develop when the engine is shut-down with the auxiliary pump switch in the ON position.
- During very hot weather, caution should be exercised to prevent overpriming the engines.
- Should fuel priming or auxiliary pump operation periods in excess of 60 seconds occur, the engine manifold must be purged by one of the following procedures:
  - (a) With auxiliary fuel pump switch OFF, allow manifold to drain at least 5 minutes or until fuel ceases to flow out of the drain under the nacelle.
  - (b) If circumstances do not allow natural draining periods recommended above, with the auxiliary pump switch OFF, magneto switches OFF, mixture idle cut-off and throttle full open, turn engine with starter or by hand a minimum of 15 revolutions.

- (6) Auxiliary Fuel Pump - LOW (to purge vapor from fuel system).
- (7) Throttle - 1000 to 1200 RPM.

- (8) Oil Pressure - 10 PSI minimum in 30 seconds in normal weather or 60 seconds in cold weather. If no indication appears, shut-down engine and investigate.
- (9) Right Engine - START (repeat steps 3 through 8).
- (10) External Power Source - UNPLUG.
- (11) Battery and Alternator Switches - ON.
- (12) Alternators - CHECK.
- (13) Rotating Beacon - ON.
- (14) Radios - ON.
- (15) Flaps - RETRACT.

## BEFORE TAKEOFF

- (1) Parking Brake - SET.
- (2) Engine Runup:
  - (a) Throttles - 1700 RPM.
  - (b) Alternators - CHECK.
  - (c) Magnetos - CHECK (150 RPM maximum drop with a maximum differential of 50 RPM).
  - (d) Propellers - CHECK feathering to 1200 RPM; return to high RPM (full forward position).
  - (e) Engine Instruments - CHECK green arc.
  - (f) Vacuum System - CHECK (4.75 to 5.25 inches Hg.).
  - (g) Throttles - 1000 RPM.

### NOTE

It is important that the engine oil temperature be within the normal operating range prior to applying takeoff power.

- (3) Flight Controls - CHECK (free and correct).
- (4) Trim Tabs - SET.
- (5) Alternate Air Controls - Check IN.
- (6) Fuel Selectors - RECHECK - Left Engine - LEFT MAIN (feel for detent).  
Right Engine - RIGHT MAIN (feel for detent).
- (7) Wing Flaps - 0°.

- (8) Cabin Door and Window - CLOSED and LOCKED.
- (9) Fuel Quantity - CHECK.
- (10) If Electric Gyro Horizon is installed, Gyro Horizon - PULL to erect.
- (11) Flight Instruments and Radios - SET.
- (12) Lights - AS REQUIRED.
- (13) Auxiliary Fuel Pumps - ON.
- (14) Parking Brake - RELEASE.

## TAKEOFF

### NORMAL TAKEOFF

- (1) Power - FULL THROTTLE and 2625 RPM.

#### NOTE

Apply full throttle smoothly to avoid propeller surging.

- (2) Mixtures - LEAN for field elevation.

#### NOTE

Leaning during the takeoff roll is normally not necessary; however, should maximum takeoff or subsequent engine-out performance be desired, fuel flow should be adjusted to match field elevation.

- (3) Elevator Control - Raise nosewheel at 90 MPH IAS.
- (4) Minimum Control Speed - 86 MPH IAS.
- (5) Break Ground at 105 MPH IAS.
- (6) Brakes - Apply momentarily.
- (7) Landing Gear - RETRACT.

- (8) Climb Speed - 123 MPH IAS (multi-engine best rate-of-climb speed). Set up climb speed as shown in NORMAL CLIMB paragraph).
- (9) Auxiliary Fuel Pumps - OFF.

### **MAXIMUM PERFORMANCE TAKEOFF**

- (1) Auxiliary Fuel Pumps - ON.
- (2) Wing Flaps - 15°.
- (3) Power - FULL THROTTLE and 2625 RPM.
- (4) Elevator Control - Raise nosewheel at 84 MPH IAS.
- (5) Minimum Control Speed - 86 MPH IAS.
- (6) Break Ground at 89 MPH IAS - Hold speed until all obstacles are cleared.
- (7) Brakes - APPLY momentarily.
- (8) Landing Gear - Retract.
- (9) Flaps - Retract (after obstacles are cleared).
- (10) Auxiliary Fuel Pumps - OFF.

## **CLIMB**

### **NORMAL CLIMB**

- (1) Airspeed - 130-150 MPH IAS.
- (2) Power - 24 inches Hg. and 2450 RPM.
- (3) Mixtures - ADJUST to climb fuel flow.
- (4) Auxiliary Fuel Pumps - ON (above 12,000 feet altitude to minimize vapor formation).

### **NOTE**

During very hot weather, if there is an indication of vapor in the fuel system (fluctuating fuel flow) or anytime when climbing above 12,000 feet, turn the auxiliary fuel pumps ON until cruising altitude has been obtained and the system is purged (usually 5 to 15 minutes after establishing cruising flight).

## MAXIMUM PERFORMANCE CLIMB

- (1) Airspeed - 123 MPH IAS at sea level; 121 MPH IAS at 10,000 feet.
- (2) Power - FULL THROTTLE and 2625 RPM.
- (3) Mixtures - ADJUST for altitude and power.
- (4) Auxiliary Fuel Pumps - ON (above 12,000 feet altitude to minimum vapor formation).

### NOTE

During very hot weather, if there is an indication of vapor in the fuel system (fluctuating fuel flow) or anytime when climbing above 12,000 feet, turn the auxiliary fuel pumps ON until cruising altitude has been obtained and the system is purged (usually 5 to 15 minutes after establishing cruising flight). It is recommended that the mixture remain at the climb mixture setting for approximately 5 minutes after establishing cruising flight before leaning is initiated.

## CRUISING

- (1) Cruise Power - 15-24 inches Hg. and 2100-2450 RPM.
- (2) Mixtures - LEAN for desired cruise fuel flow as determined from your power computer. Recheck mixtures if power, altitude or OAT changes.
- (3) Fuel Selectors - Left Engine - LEFT MAIN (feel for detent).  
Right Engine - RIGHT MAIN (feel for detent).
  - (a) If optional 40 gal. auxiliary tanks are installed, fuel selectors - MAIN TANKS for 60 minutes.
  - (b) If optional 63 gal. auxiliary tanks are installed, fuel selectors - MAIN TANKS for 90 minutes.
  - (c) If wing locker tanks are installed, fuel selectors - MAIN TANKS or; after wing locker tanks are transferred and main tank quantity is less than 180 pounds each - AUXILIARY TANKS.



## NOTE

Turn auxiliary fuel pumps to **LOW** and mixtures to **FULL RICH** when switching tanks.

- (d) If wing locker tanks are installed, crossfeed - **SELECT** as required to maintain fuel balance after wing locker tank fuel transfer.
- (4) Trim Tabs - **ADJUST**.

## LETDOWN

- (1) Power - As required.
- (2) Mixtures - **ADJUST** for smooth operation with gradual enrichment as altitude is lost.

## BEFORE LANDING

- (1) Fuel Selectors - Left Engine - **LEFT MAIN** (feel for detent).  
Right Engine - **RIGHT MAIN** (feel for detent).
- (2) Alternate Air Controls - Check **IN**.
- (3) Mixtures - Full Rich - or lean as required for smooth operation.
- (4) Propellers - **FULL FORWARD**.
- (5) Wing Flaps -  $15^{\circ}$  below 180 MPH CAS.
- (6) Landing Gear - **EXTEND** below 160 MPH CAS.
- (7) Landing Gear Position Indicator Lights - **CHECK** green lights **ON** and red unlocked light **OFF**.
- (8) Wing Flaps -  $15^{\circ}$  to  $35^{\circ}$  below 160 MPH CAS.
- (9) Auxiliary Fuel Pumps - **ON**.
- (10) Minimum Approach Speed - 103 MPH IAS.
- (11) Minimum Single-Engine Control Speed - 86 MPH IAS.

## LANDING

- (1) Touchdown - Main wheels first.
- (2) Landing Roll - Lower nosewheel gently.
- (3) Braking - As required.

## GO-AROUND (Multi-Engine)

- (1) Increase engine speed to 2625 RPM and apply full throttle if necessary.
- (2) Reduce flaps setting to 15°.
- (3) Trim aircraft for climb.
- (4) Retract flaps as soon as all obstacles are cleared and a safe altitude and airspeed are obtained.

### NOTE

Do not retract landing gear if another landing approach is to be conducted.

## AFTER LANDING

- (1) Auxiliary Fuel Pumps - LOW (during landing roll).
- (2) Wing Flaps - UP.

## SECURE AIRCRAFT

- (1) Auxiliary Fuel Pumps - OFF.
- (2) All Switches except Battery, Alternator and Magneto Switches - OFF.
- (3) Throttles - IDLE.
- (4) Propellers - FORWARD.
- (5) Mixtures - IDLE CUT-OFF.
- (6) Fuel Selectors - OFF.

### NOTE

Do not leave the fuel selectors in the intermediate position as fuel from the main tip tanks will transfer into the auxiliary tanks.

- (7) Magneto Switches - OFF, after engines stop.
- (8) Battery and Alternators - OFF.
- (9) Brakes - SET.
- (10) Control Lock(s) - INSTALL.
- (11) Cabin Door - CLOSE.

**NOTE**

To securely latch the cabin door from the outside, the exterior door handle must be rotated clockwise to its stop.

*Notes* .....

## SECTION II

### DESCRIPTION AND OPERATING DETAILS

---

The following paragraphs supply a general description of some systems and equipment in the aircraft. This section also covers, in somewhat greater detail, some of the items in Checklist Form in Section I. Only those items of the Checklist requiring further explanation will be covered here.

### PREFLIGHT INSPECTION

The preflight inspection, described in Section I, is recommended for the first flight of the day. Inspection procedures for subsequent flights are normally limited to brief checks of the tail surface hinges, fuel and oil quantity, and security of fuel and oil filler caps. If the aircraft has been in extended storage, has had recent major maintenance, or has been operated from marginal airports, a more extensive preflight inspection is recommended.

After major maintenance has been performed, the flight and trim tab controls should be double-checked for free and correct movement and security. The security of all inspection plates on the aircraft should be checked following periodic inspections. Since radio and heater maintenance requires the mechanic to work in the nose compartment, the nose compartment access panels are opened for access to equipment. Therefore, it is important after such maintenance to double-check the security of these access panels. If the aircraft has been waxed or polished, check the external static pressure source holes for stoppage.

If the aircraft has been exposed to much ground handling in a crowded hangar, it should be checked for dents and scratches on wings, tip tanks, fuselage, and tail surfaces, as well as damage to navigation and landing lights, deicer boots, and radio antenna. Outside storage for long periods may result in water and obstructions in airspeed system lines, condensation in fuel tanks, and dust and dirt on the intake air filters and engine cooling fins. Outside storage in windy or gusty areas, or adjacent to taxiing aircraft calls for special attention to control surface stops, hinges and brackets to detect the presence of wind damage.

If the aircraft has been operated from muddy fields or in snow and slush, check the main gear wheel and nose gear wheel wells for obstructions and cleanliness. Operation from a gravel or cinder field will re-

quire extra attention to propeller tips and abrasion on leading edges of the horizontal tail. Stone damage to the outer six-inches of the propeller tips can seriously reduce the fatigue life of the blades.

Aircraft that are operated from rough fields, especially at high altitudes, are subjected to abnormal landing gear abuse. Check frequently all components of the landing gear retracting mechanisms, shock struts, tires and brakes.

To prevent loss of fuel in flight, make sure main and auxiliary fuel tank filler caps are tightly sealed. The main fuel tank vents beneath the tip tanks should also be inspected for obstructions, ice or water, especially after operation in cold, wet weather.

The interior inspection will vary according to the mission and the optional equipment installed. Prior to high-altitude flights, it is important to check the condition and quantity of oxygen face masks and hose assemblies. The oxygen supply system should be functionally checked to insure that it is in working order. The oxygen pressure gage should indicate between 300 and 1800 PSI depending upon the anticipated requirements.

Satisfactory operation of the pitot tube, stall warning transmitter and main fuel tank vent heating elements is determined by observing a discharge on the ammeter when the pitot heat switch is turned ON. The effectiveness of the pitot tube and stall warning transmitter heating elements may be verified by cautiously feeling the heat of both devices while the pitot heat switch is ON.

Flights at night and in cold weather involve a careful check of other specific areas which will be discussed later in this section.

## **STARTING ENGINES**

The left engine is normally started first because the cable from the battery to this engine is much shorter permitting more electrical power to be delivered to the starter. If battery is low, the left engine should start more readily.

When using an external power source, it is recommended to start the aircraft with the battery and alternator switches OFF.

NOTE

Release starter switch as soon as engine fires or engine will not accelerate and flooding can result.

The continuous flow fuel injection system will start spraying fuel in the engine intake ports as soon as the primer switch is actuated and the throttle and mixture controls are opened. To avoid flooding, begin cranking the engine prior to priming the engine.

In hot weather with a hot engine, a fluctuating fuel flow slightly lower than normal may be obtained. This is an indication of vaporized fuel and the starter should not be energized until a steady fuel flow indication is obtained.

NOTE

Caution should be exercised to prevent overpriming the engine in hot weather.

Engine mis-starts characterized by weak, intermittent explosions, followed by black puffs of smoke from the exhaust are the result of flooding or overpriming. This situation is more apt to develop in hot weather, or when the engines are hot. If it occurs, repeat the starting procedure with the throttle approximately 1/2 open, the mixture in IDLE CUT-OFF and the primer switch OFF. As the engine fires, move the mixture control to FULL RICH and close the throttle to idle.

If an engine is underprimed, as may occur in cold weather with a cold engine, repeat the starting procedure while holding the primer switch on for 5 to 10 seconds until the engine fires.

If cranking longer than 30 seconds is required, allow starter-motor to cool five minutes before cranking again, since excessive heat may damage the armature windings.

After the engines are started, the auxiliary fuel pumps should be switched to LOW to provide for improved purging and vapor clearing in the fuel system.

## **TAXIING**

A steerable nosewheel, interconnected with the rudder system, provides positive control up to 18° left or right, and free turning from 18° to 55° for sharp turns during taxiing. Normal steering may be aided through use of differential power and differential braking on the main wheels. These aids are listed in the preferred order of use.

At some time early in the taxi run, the brakes should be tested, and any unusual reaction, such as uneven braking, should be noted. If brake operation is not satisfactory, the aircraft should be returned to the tie-down location and the malfunction corrected. The operation of the turn-and-bank indicator and directional gyro should also be checked during taxiing.

Most of the engine warm-up should be done during taxiing, with just enough power to keep the aircraft moving. Engine speed should not exceed 1000 RPM while the oil is cold.

## **BEFORE TAKEOFF (Use the Pilot's Checklist)**

Use the Pilot's Checklist in the aircraft to prevent the possibility of overlooking an important check item.

Most of the warm-up will have been conducted during taxi, and additional warm-up before takeoff should be restricted to the checks outlined in Section I.

Full throttle checks on the ground are not recommended unless there is good reason to suspect that the engines are not operating properly. Do not runup the engines over loose gravel or cinders because of possible stone damage or abrasion to the propeller tips.

If the magnetos produce an engine speed drop in excess of 150 RPM, or if the drop in RPM between the left and right magneto differs by more than 50 RPM, continue warm-up a minute or two longer, before rechecking the system. If there is doubt concerning operation of the magnetos,



checks at higher engine speed will usually confirm if a deficiency exists. In general, a drop in excess of 150 RPM is not considered acceptable.

If instrument flights are contemplated, a careful check should be made of the vacuum system. The minimum and maximum allowable suction are 4.75 and 5.25 inches Hg., respectively, on the instrument. Good alternator condition is also important for instrument flight, since satisfactory operation of all radio equipment and electrical instruments is essential. The alternators are checked during engine runup (1700 RPM) by positioning the selector switch in the L ALT and R ALT position and observing the charge rate on the ammeter.

A simple last minute recheck of important items should include a quick glance to see if all switches are ON, the mixture and propeller pitch levers are forward, all flight controls have free and correct movement, and the fuel selectors are properly positioned.

A mental review of all single engine speeds, procedures, and field length requirements should be made prior to takeoff.

## TAKEOFF

Since the use of full throttle is not recommended in the static runup, closely observe full-power engine operation early in the takeoff run. Signs of rough engine operation, unequal power between engines, or sluggish engine acceleration are good cause for discontinuing the takeoff. If this occurs, you are justified in making a thorough, full throttle, static runup before another takeoff is attempted.

For maximum engine power, the mixture should be adjusted during the initial acceleration for smooth engine operation at the field elevation. The engine acceleration is increased significantly with fuel leaning above 3000 feet and this procedure always should be employed for field elevations greater than 5000 feet above sea level.

MULTI-ENGINE AIRSPEED NOMENCLATURE		MPH - IAS
(1)	Multi-Engine Best Rate-of-Climb . . . . .	123
(2)	Multi-Engine Best Angle-of-Climb . . . . .	93
(3)	Takeoff and Climb to 50 Ft. . . . .	105
(4)	Landing Approach from 50 Ft. . . . .	103

Figure 2-1

Full throttle operation is recommended on takeoff since it is important that a speed well above minimum single-engine control speed (86 MPH IAS) be obtained as rapidly as possible. It is desirable to accelerate the aircraft to 105 MPH IAS (recommended safe single-engine speed) while still on the ground for additional safety in case of an engine failure. This safety may have to be compromised slightly where short and rough fields prohibit such high speed before takeoff.

After takeoff it is important to maintain the recommended safe single-engine climb speed (105 MPH IAS). As you accelerate still further to best single-engine rate-of-climb speed (116 MPH IAS), it is good practice to climb rapidly to an altitude at which the aircraft is capable of circling the field on one engine.

After obstruction height is reached, power may be reduced and climb speeds may be established as described in Section I.

On long runways, the landing gear should be retracted at the point over the runway where a wheels-down, forced landing on that runway would become impractical. However, on short runways it may be preferable to retract the landing gear after the aircraft is safely airborne.

For crosswind takeoffs, additional power may be carried on the upwind engine until the rudder becomes effective. The aircraft is accelerated to a slightly higher than normal takeoff speed, and then is pulled off abruptly to prevent possible settling back to the runway while drifting. When clear of the ground, a coordinated turn is made into the wind to correct for drift.

A takeoff with one tip tank full and the opposite tank empty creates a lateral unbalance at takeoff speed. This is not recommended since gusty air or premature lift-off could create a serious control problem.

Performance data for normal takeoff, accelerate stop distance and single-engine takeoff are presented in Section VI.

## AFTER TAKEOFF

To set up the aircraft in climb configuration, retract the landing gear, adjust power for climb, turn off the auxiliary fuel pumps and adjust the mixture for the power setting selected.

Power reduction will vary according to the requirements of the traffic pattern or surrounding terrain, gross weight, field elevation, temperature and engine condition. However, a normal "after takeoff" power setting is 24 inches Hg. and 2450 RPM.

Before retracting the landing gear, apply the brakes momentarily to stop the main wheels. Centrifugal force caused by the rapidly-rotating wheels expands the diameter of the tires, and if ice or mud has accumulated in the wheel wells, the rotating wheels may rub as they enter.

## CLIMB

To save time and fuel for the over-all trip, it is recommended that the normal cruising climb be conducted at 130 to 150 MPH IAS using approximately 75% power (24 inches Hg., and 2450 RPM).

The mixture should be leaned in this type of climb to give the desired fuel flow in the climb dial range which is approximately best power mixture.

If it is necessary to climb rapidly to clear mountains or reach favorable winds at high altitudes, the best rate-of-climb speed should be used with maximum power. This speed varies from 123 MPH IAS at sea level to 121 MPH IAS at 10,000 feet. During maximum performance climbs, the mixture should be leaned to the appropriate altitude markings on the fuel flow gage. It is recommended that the auxiliary fuel pumps be on at altitudes above 12,000 feet for the duration of the climb and approximately 5 to 15 minutes after establishing cruising flight. It is also recommended that the mixture remain at the climb mixture setting for approximately 5 minutes after establishing cruising flight before leaning is initiated. These procedures will eliminate fuel vaporization problems likely to occur from rapid altitude changes.

If an obstruction ahead requires a steep climb angle, the aircraft should be flown at the best angle-of-climb speed with flaps up and maximum power. The speed varies from 93 MPH IAS at sea level to 110 MPH IAS at 15,000 feet. Performance data for maximum climb, cruise climb and single-engine climb are presented in Section VI.

## **CRUISE**

Tabulated cruising information is provided for normal power and altitudes in Section VI. These charts are based on 600, 978 and 1218 pounds of fuel for cruise, recommended lean mixture, 5300 pounds gross weight, zero wind, and no fuel reserve. Allowances for warm-up, takeoff and climb, headwinds, variations in mixture leaning technique, and fuel reserve should be estimated, and the endurance and range shown in the charts should be modified accordingly. Fuel allowances for takeoff and climb are given in Section VI.

Normal cruising requires between 60% and 70% power. The manifold pressure and RPM settings required to obtain these powers at various altitudes and outside air temperatures can be determined with your power computer. A maximum cruising power of approximately 75% (24 inches Hg., and 2450 RPM) may be used if desired.

Various percent powers can be obtained with a number of combinations of manifold pressures, engine speeds, altitudes, and outside air temperatures. However, at full throttle and constant engine speed, a specific power can be obtained at only one altitude for each given air temperature.

The power computer is marked with two fuel flow scales. These scales are provided to ensure that you can obtain the maximum performance and utilization from your Cessna. The inner fuel flow scale (marked recommended lean) should be utilized for all normal cruise performance. Data shown in Section VI are based on recommended lean mixture. The outer fuel flow scale (marked best power) will provide maximum speed for a given power setting. The speed will be approximately two MPH greater than the speed with recommended lean mixture. Operation at best power mixture will significantly increase exhaust system, engine valve and ring life, particularly the exhaust system.

For a given throttle setting, select the lowest engine speed in the green arc range that will give smooth engine operation without evidence of laboring.

For best propeller synchronizing, the final adjustment of the propeller pitch levers should be made in a DECREASE RPM direction.

Refer to the optional fuel system paragraphs in Section VII for proper fuel system management when the Auxiliary Fuel Tanks and/or the Wing Locker Fuel Tanks are used.

## ALTERNATE INDUCTION AIR SYSTEM

The induction air system on these engines is considered to be non-icing. However, to preclude the possibility of the alternate induction air door or control freezing up the manually-operated alternate induction air system should be utilized prior to entering suspected induction icing conditions. Induction icing conditions are considered to exist any time the temperature is below 35° F with visible moisture present or any time the temperature is below 35° F and the temperature/dew point spread is less than 5° F.

The use of alternate intake air results in higher induction air temperatures and decreases engine power. Therefore, it is recommended that the alternate induction air system be used only if icing conditions are expected.

Should additional power be required, while utilizing the alternate induction air system, the following procedure should be employed.

- (1) Push propeller levers full forward for 2625 RPM. This will insure that the maximum power available is being used.
- (2) Move throttles forward until maximum manifold pressure is reached.
- (3) Readjust mixture control for smooth engine operation.

## STALL

The stall characteristics of the aircraft are conventional and aural warnings are provided by the stall warning horn between 5 and 10 MPH above the stall in all configurations. The stall is also preceded by a mild aerodynamic buffet which increases in intensity as the stall is approached. The power-on stall occurs at a very steep angle, with or without flaps, and it is difficult to inadvertently stall the aircraft during normal maneuvering.

Power-off stall speeds at maximum weight and various bank angles are presented in Section VI.

#### NOTE

The stall warning system is inoperative when the battery switch is in the "OFF" position.

## MANEUVERING FLIGHT

No aerobatic maneuvers, including spins, are approved in this aircraft. The aircraft is, however, conventional in all respects through the maneuvering range encountered in normal flight.

## SPINS

Intentional spins are not permitted in this aircraft. Should a spin occur, however, the following recovery procedures should be employed:

- (1) Cut power on both engines.
- (2) Apply full rudder opposing the direction of rotation.
- (3) Approximately 1/2 turn after applying rudder, push control wheel forward briskly.
- (4) To expedite recovery, add power to the engine toward the inside of the direction of turn.
- (5) Pull out of resulting dive with smooth, steady control pressure.

## LETDOWN

Lettowns should be initiated far enough in advance of estimated landing to allow a gradual rate of descent at cruising speed. It should be at approximately 500 fpm for passenger comfort, using enough power to keep the engines warm. This will prevent undesirable low cylinder head temperatures caused by low power settings at cruise speed. The optimum engine speed in a letdown is usually the lowest one in the RPM green arc range that will allow cylinder head temperatures to remain in the recommended operating range.

To prevent confusion in interpreting which 10,000 foot segment of altitude is being displayed on the altimeter, a striped warning segment is exposed on the face of the altimeter at all altitudes below 10,000 feet.

## BEFORE LANDING

If fuel has been consumed at uneven rates between the two main tanks because of prolonged single-engine flight, it is desirable to balance the fuel load by operating both engines from the fullest tank. However, if there is sufficient fuel in both tanks, even though they may have unequal quantities, it is important to switch the left and right selector valves to the left and right main tanks respectively, and feel for detent, for the landing. This will provide an adequate fuel flow to each engine if a full-power go-around is necessary.

Landing gear extension before landing is easily detected by a slight change in aircraft trim and a slight "bump" as the gear locks down. Illumination of the gear-down indicator lights (green), is further proof that the gear is down and locked. The gear unlocked indicator light (red) will illuminate when the gear uplocks are released and will remain illuminated while the gear is in transit. The unlocked light will extinguish when the gear has locked down. If it is reasonably certain that the gear is down and one of the gear-down indicator lights is still not illuminated, the malfunction could be caused by a burned out light bulb. This can be checked by pushing-to-test. If the bulb is burned out, it can be replaced with the bulb from either the compass light, turn-and bank test light, or the landing gear up indicator light.

A simple last-minute recheck on final approach should confirm that all applicable switches are ON, the gear-down indicator lights (green) are illuminated, the gear unlocked indicator light is extinguished, and the propeller and mixture controls are full forward.

## LANDING

Landings are simple and conventional in every respect. If power is used in landing approaches, it should be eased off cautiously near touchdown, because the "power-on" stall speed is considerably less than the "power-off" stall speed. An abrupt power reduction at five feet altitude could result in a hard landing if the aircraft is near stall speed.

Landings on hard-surface runways are performed with 35° flaps from 103 MPH IAS approach, using as little power as practicable. A normal flare-out is made, and power is reduced in the flare-out. The landing is

made on the main wheels first, and remaining engine power is cut immediately after touchdown. The nosewheel is gently lowered to the ground and braking is applied as required. Short field landings on rough or soft runways are done in a similar manner except that the nosewheel is lowered to the runway at a lower speed to prevent excessive nose gear loads.

Crosswind landings are performed with the least effort by using the crab method. However, either the wing-low, crab or combination method may be used. Crab the aircraft into the wind in a normal approach, using a minimum flap setting for the field length. Immediately before touchdown, the aircraft is aligned with the flight path by applying down-wind rudder. The landing is made in nearly three-point attitude, and the nosewheel is lowered to the runway immediately after touchdown. A straight course is maintained with the steerable nosewheel and occasional braking if necessary.

Landing performance data is presented in Section VI.

## AFTER LANDING

Heavy braking in the landing roll is not recommended because skidding the main wheels is probable, with resulting loss of the braking effectiveness and damage to the tires. It is best to leave the flaps fully extended throughout the landing roll to aid in decelerating the aircraft. After leaving the active runway, the flaps should be retracted. Be sure the flap switch is identified before placing it in the UP position. The auxiliary fuel pump switches normally are turned to LOW while taxiing to the hangar. The fuel pumps must be turned off prior to stopping engines.

Parking is normally accomplished with the nosewheel aligned straight ahead. This simplifies the steering during subsequent departures from the parking area. However, if gusty wind conditions prevail, the nosewheel should be castered to the extreme right or left position. This forces the rudder against the rudder stop which minimizes buffeting of the rudder in gusty wind.

With the mixture levers in IDLE CUT-OFF, the fuel flow is effectively blocked at the fuel metering unit. Thus, it is unnecessary to place the fuel selector valve handles in the OFF position if the aircraft is receiving normal usage. However, if a long period of inactivity is anticipated, the fuel selector valve handles should be turned OFF to preclude any possible fuel seepage that might develop through the metering valve.



## NOTE

Do not leave the fuel selector handles in an intermediate position, as fuel from the main tip tanks will transfer into the auxiliary tanks if optional auxiliary fuel tanks are installed in your aircraft.

## NIGHT FLYING

Before starting engines for a night flight, rheostats should be turned on and adjusted to provide enough illumination to check all switches, controls, etc.

Navigation lights are then checked by observing illumination in the small peep holes in the inboard leading edges of the wing tip tanks and reflection from the pavement or ground below the tail light. The operation of the rotating beacons should be checked by observing the reflections on the ground and on the tip tanks and wings. The retractable landing lights (the right landing light is optional equipment) may be extended and checked momentarily. Returning the landing light switches to OFF turns the lights off but leaves them extended ready for instant use.

Before taxi, the interior lighting intensity is normally decreased to the minimum at which all the controls and switches are visible. The taxi light should be turned on prior to taxiing at night. The landing lights, if used during taxiing, should be used intermittently to avoid excessive drain on the batteries. In the engine runups, special attention should be directed to alternator operation by individually turning the selector switch to L ALT and R ALT and noting response on the ammeter.

Night takeoffs are conventional, although gear retraction operation is usually delayed slightly to insure the aircraft is well clear of the runway.

In cruising flight, the interior lighting intensity should be decreased to the minimum which will provide adequate instrument legibility. This intensity should be readjusted periodically during flight as the degree of night vision adaptation or exterior ambient light level changes. Care should be exercised when increasing the intensity of illumination to preclude inadvertent deterioration of night vision adaptation.

## **COLD WEATHER OPERATION**

Whenever possible, external preheat should be utilized in cold weather. The use of preheat materially reduces the severity of conditions imposed on both engines and electrical systems. It is the preferred or best method of starting engines in extremely cold weather. Preheat will thaw the oil trapped in the oil coolers and oil filters, which will probably be congealed prior to starting in very cold weather. When the oil pressure gage is extremely slow in indicating pressure, it may be advisable to fill the pressure line to the gage with kerosene or JP4.

If preheat is not available, external power should be used for starting because of the higher cranking power required and the decreased battery output at low temperatures. The starting procedure is normal; however, if the engines do not start immediately, it may be necessary to position the primer switch to LEFT or RIGHT for 5 to 10 seconds.

After a suitable warm-up period (2 to 5 minutes at 1000 RPM, if preheat is not used) accelerate the engines several times to higher RPM. The propellers should be operated through several complete cycles to warm the governors and propeller hubs. If the engines accelerate smoothly and the oil pressure remains normal and steady, the aircraft is ready for takeoff.

During cruise the propellers should be exercised at half-hour intervals to flush the cold oil from the governors and propeller hubs. Electrical equipment should be managed to assure adequate alternator charging throughout the flight, since cold weather adversely affects battery capacity.

During letdown, watch engine temperature closely and carry sufficient power to maintain them above operating minimums.

The pitot, tip tank vents and stall warning heater switches should be turned ON at least 5 minutes before entering potential icing conditions (2 minutes if on the ground) so that these units will be warm enough to prevent formation of ice. Preventing ice is preferable to attempting its removal once it has formed.

Refer to Section VII for optional cold weather equipment.

# FUEL SYSTEM . . . . . schematic

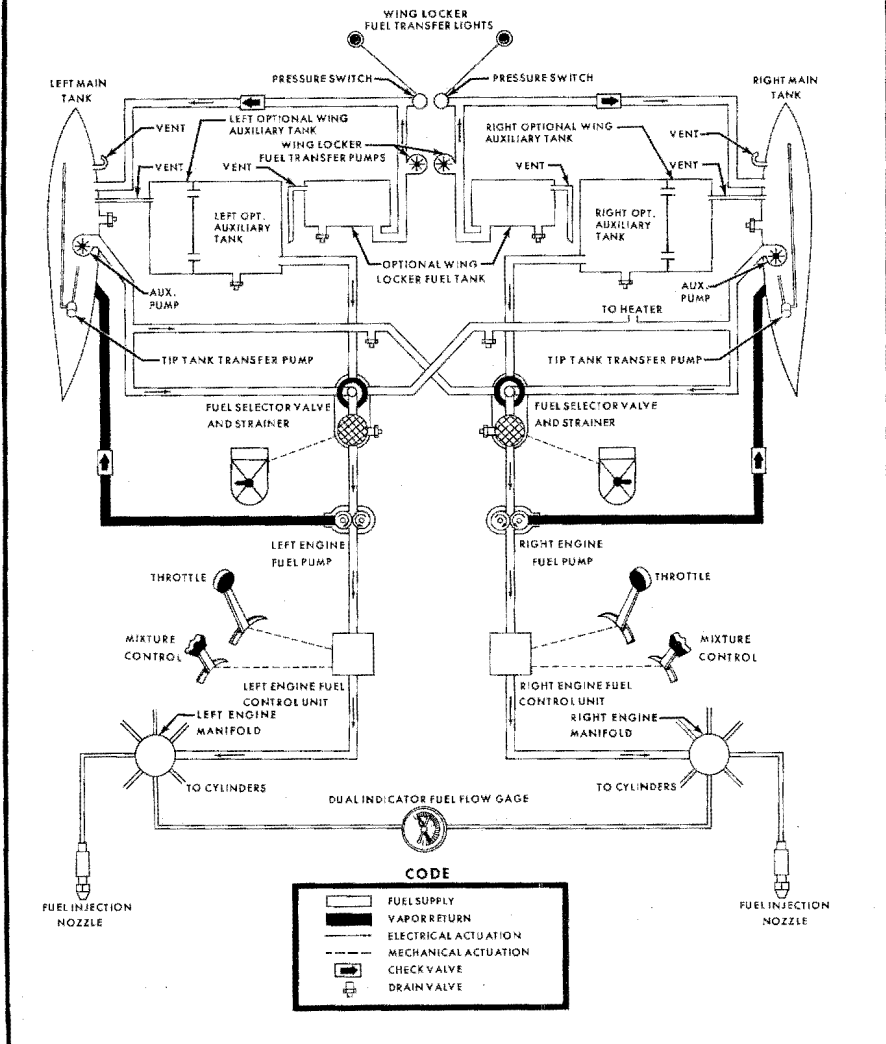

**CODE**

	FUEL SUPPLY
	VAPOR RETURN
	ELECTRICAL ACTUATION
	MECHANICAL ACTUATION
	CHECK VALVE
	DRAIN VALVE

Figure 2-2

## FUEL SYSTEM

Fuel for each engine is supplied by a main tank (50 gallons usable) on each wing tip. Each engine has its own complete fuel system; the two systems are interconnected only by a cross-feed for emergency use. Vapor and excess fuel from the engines are returned to the main fuel tanks. Submerged electric auxiliary pumps in the main fuel tanks supply fuel for priming and starting, and for engine operation as a backup system to the engine-driven pumps. See Figure 2-2 for Fuel System Schematic and optional fuel systems paragraphs in Section VII for additional information.

A continuous duty tip tank transfer pump is installed in each main tip tank. The pumps assure availability of all tip tank fuel to the engine supply line during high angles of descent. Each pump is electrically protected by the respective landing light circuit breaker. When the right-hand landing light is not installed, a circuit breaker is installed to protect the right-hand transfer pump. During preflight inspection these pumps can be checked for operation by listening for a pulsing sound emanating from the aft tip tank fairings with the battery switch in the ON position.

### NOTE

During very hot weather, if there is an indication of vapor in the fuel system (fluctuating fuel flow) or anytime when climbing above 12,000 feet, turn the auxiliary fuel pumps ON until cruising altitude has been obtained and the system is purged (usually 5 to 10 minutes after establishing cruising flight). It is recommended that the mixture remain at the climb mixture setting for approximately 5 minutes after establishing cruising flight before leaning is initiated.

### FUEL SELECTOR VALVE HANDLES

The fuel selector valve placards are marked LEFT ENGINE OFF, LEFT MAIN and RIGHT MAIN for the left engine selector, and RIGHT ENGINE OFF, RIGHT MAIN and LEFT MAIN for the right engine selector. The cross-feed position of each selector valve is the one marked for the opposite main tank.

The fuel selector valve handles form the pointers for the selectors. The ends of the handles are arrow-shaped and point to the position on the selector placard which corresponds to the valve position.

#### NOTE

- The fuel selector valve handles should be turned to **LEFT MAIN** for the left engine and **RIGHT MAIN** for the right engine, during takeoff, landing, and emergency.
- When fuel selector valve handles are changed from one position to another, the auxiliary fuel pumps should be switched to low, the mixture should be in **FULL RICH** and the pilot should feel for the detent to insure that fuel selector valve is properly positioned.

#### AUXILIARY FUEL PUMP SWITCHES

The **LOW** position runs the pumps at low speed, providing 36 pounds per hour fuel flow for purging. The **ON** position also runs the pumps at low speed, as long as the engine-driven pumps are functioning. With the switch positioned to **ON**, however, if an engine-driven pump should fail, the auxiliary pump on that side will switch to high speed automatically, providing sufficient fuel for all engine operations including emergency takeoff. The auxiliary fuel pump will not run in any position unless the engine oil pressure on that side is at least 20 PSI.

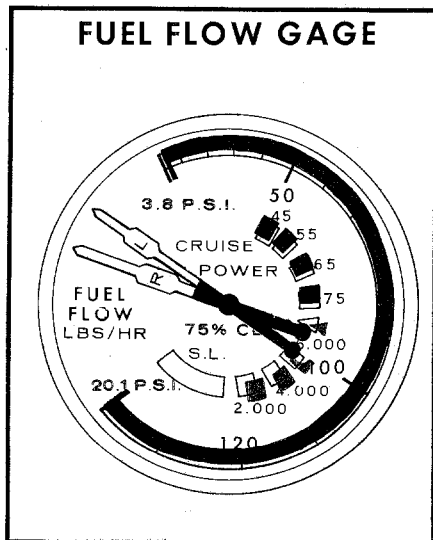

Figure 2-3

## FUEL FLOW GAGE

The fuel flow gage is a dual instrument which indicates the approximate fuel consumption of each engine in pounds per hour. The fuel flow gage used with the Continental injection system senses the pressure at which fuel is delivered to the engine spray nozzles. Since fuel pressure at this point is approximately proportional to the fuel consumption of the engine, the gage is marked as a flowmeter.

The gage dial is marked with arc segments corresponding to proper fuel flow for various power settings and is used as a guide to quickly set the mixtures. The gage has markings for takeoff, climb and cruise power settings for various altitudes. The takeoff and climb markings indicate maximum performance mixtures for maximum power available for altitudes shown (2625 RPM and full throttle), making it practical to lean the mixtures on a high-altitude takeoff.

In the cruise power range, recommended lean mixtures are attained when the fuel flow pointers cover the green segment for that percentage of power. In the takeoff and climb range, each segment represents a maximum-power mixture for an altitude range; the low flow edge is the setting for the marked altitude and the high flow edge is the setting for a thousand feet lower. The sea level segment represents the range for maximum rated power at sea level.

### NOTE

The fuel flow settings on the takeoff and climb power segments of the dial are for 2625 RPM and full throttle, only. Climb power settings at lower RPM should be taken from your power computer.

## FUEL FLOW MANAGEMENT

For normal cruise conditions, your power computer should be utilized to set the fuel flows for the recommended lean mixtures. The power computer is based on true OAT, which is obtained by subtracting the ram rise from the indicated OAT. A ram rise chart is provided in the pilot's checklist.

When range is not a primary consideration for setting the fuel flows, the Best Power Scale provided on the power computer should be used. This setting will result in a higher airspeed as well as increase the engine and component life because of the lower operating temperatures.

When the optional Economy Mixture Indicator (EGT) is provided, refer to Section VII.

## **FUEL QUANTITY INDICATOR**

The fuel quantity indicators are calibrated in pounds and will accurately indicate the weight of fuel contained in the tanks. Since fuel density varies with temperature, a full tank will weigh more on a cold day than on a warm day. This will be reflected by the weight shown on the gage. A gallons scale is provided in blue on the indicator for convenience in allowing the pilot to determine the approximate volume of fuel on board.

## **FUEL STRAINER AND TANK SUMP DRAINS**

Refer to Lubrication and Servicing Procedures, Section V.

## **ELECTRICAL SYSTEM**

Electrical energy is supplied by a 28-volt, negative-ground, direct-current system, powered by a standard 50 ampere, or optional 100 ampere, engine-driven alternator on each engine. Two 12-volt batteries, connected in series, are located in the left wing just outboard of the engine nacelle. An optional external power receptacle is installed in the left wing under the batteries. The receptacle accepts a standard external power source plug. See Figure 2-4 for Electrical Power Distribution Schematic.

## **VOLTAMMETER**

A voltammeter, located on the instrument panel, is provided to monitor alternator current output, battery charge or discharge rate and bus voltage. A selector switch, labeled L ALT, R ALT, BAT and VOLTS is located to the left of the voltammeter. By positioning the switch to L ALT, R ALT, BAT or VOLTS position, the respective alternator or the battery amperage and bus voltage can be monitored.

# ELECTRICAL POWER DISTRIBUTION SCHEMATIC

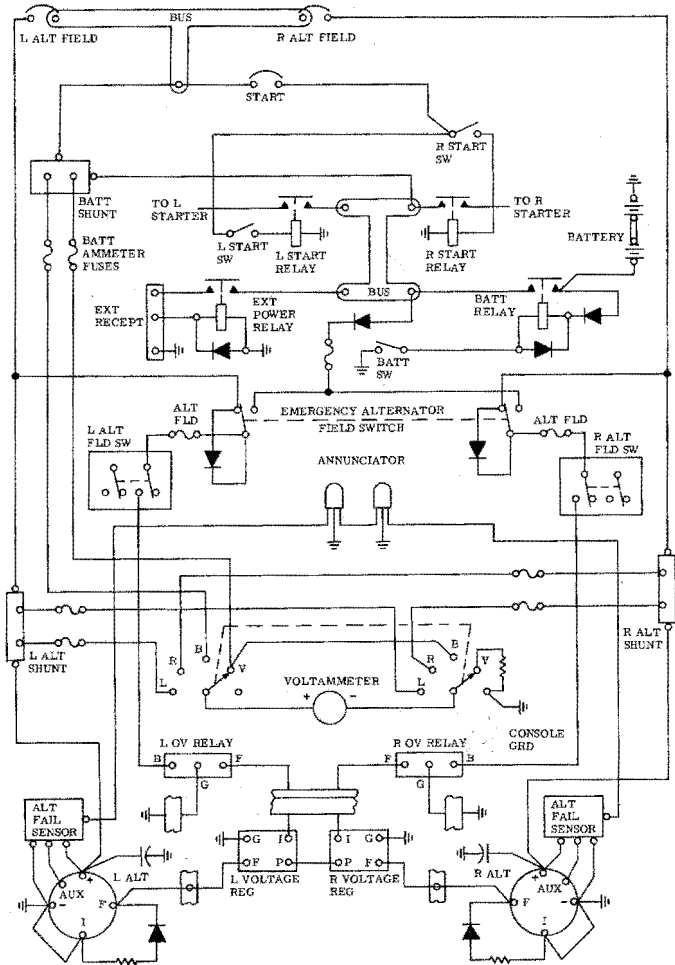

Figure 2-4



## **BATTERY AND ALTERNATOR SWITCHES**

Separate battery and alternator switches are provided as a means of checking for malfunctioning alternator circuit and permits such a circuit to be cut-off. If an alternator circuit fails or malfunctions, or when one engine is not running, the switch for that alternator should be turned off. Operation should be continued on the functioning alternator, using only necessary electrical equipment. If both alternator circuits should malfunction, equipment can be operated at short intervals and for a limited amount of time on the battery alone. In either case, a landing should be made as soon as practical to check and repair the circuits.

## **EMERGENCY ALTERNATOR FIELD SWITCH**

An emergency alternator field switch is provided in the alternator system and is located on the circuit breaker panel. The emergency alternator field switch is used when the alternators will not self excite. Placing the switch in the ON position, provides excitation from the battery even though the battery is considered to have failed.

## **OVERVOLTAGE RELAYS**

Two overvoltage relays in the electrical system constantly monitor their respective alternator output. Should an alternator exceed the normal operating voltage, that voltage relay will trip, taking the affected alternator off the line. The voltage relay can be reset by cycling the applicable alternator switch.

## **CIRCUIT BREAKERS**

All electrical circuits in the aircraft are protected by push-to-reset type circuit breakers or switch breakers (except the alternator field circuit which is protected by a fuse). Should an overload occur in any circuit, the resulting heat rise will cause the controlling circuit breaker to open the circuit. After allowing the circuit breaker to cool for approximately three minutes, it may be pushed (until a click is heard or felt) to re-energize the circuit. However, the circuit breaker should not be held in if it opens the circuit a second time, as this indicates a short circuit.

## CIRCUIT BREAKER PANEL

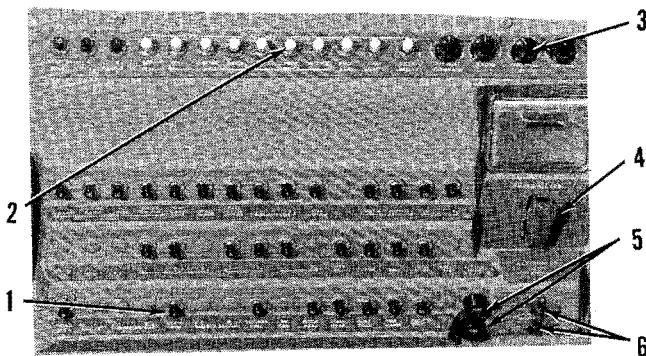

1. SYSTEM CIRCUIT BREAKERS
2. SYSTEM SWITCHES
3. LIGHTING RHEOSTAT PANEL
4. EMERGENCY ALTERNATOR FIELD SWITCH

5. LEFT AND RIGHT ALTERNATOR FIELD FUSES
6. LEFT AND RIGHT ALTERNATOR CIRCUIT BREAKERS

Figure 2-5

## ROTATING BEACON

The rotating beacon should not be used when flying through clouds, fog or haze. The reflection of the rotating light beam can cause disorientation or vertigo. If optional strobe lights are installed, refer to Section VII for additional information.

## LANDING GEAR SYSTEM

The electrically-operated landing gear is fully retractable and incorporates a steerable nosewheel. To help prevent accidental retraction, an automatic safety switch on the left shock strut prevents retraction as long as the weight of the aircraft is sufficient to compress the strut.

The landing gear is operated by a switch, which is identified by a wheel-shaped knob. The switch positions are UP, OFF (center) and DOWN. To operate the gear, pull-out the switch knob and move to the desired position.

## LANDING GEAR POSITION LIGHTS AND WARNING HORN

Four landing gear position lights are provided, one above and three below the landing gear switch. The upper light is red and will illuminate when any or all the gears are unlocked (intermediate position). The three lower lights (one for each gear) are green and will illuminate when each gear is fully extended and locked. When the gear unlocked light and gear down lights are not illuminated, the landing gear is in the UP and locked position. The lights are push-to-test type with rotatable dimming shutters.

The landing gear warning horn is controlled by the throttles and the flap preselect handle. The warning horn will sound an intermittent note if either throttle is retarded below approximately 12 inches Hg. manifold pressure with the landing gear retracted or if the flap handle is lowered past the 15° position with the landing gear in any position except extended and locked. The warning horn can be activated by either the flap handle or by throttle position as each functions independently of the other. The warning horn is also connected to the UP position of the landing gear switch and will sound if the switch is placed in the UP position while the aircraft is on the ground.

### NOTE

Do not pull landing gear warning circuit breaker to silence horn as this would also turn off the landing gear indicator lights.

## LANDING GEAR HANDCRANK

A landing gear handcrank, Figure 2-6, for manually lowering the landing gear is located just below the right front edge of the pilot's seat. Normally, the crank is folded and stowed in a clip beside the seat. To use

the crank, tilt pilot's seat aft (std) or raise pilot's seat (opt), pull crank out from its storage clip and unfold it until it locks in operating position. Move the landing gear switch to the center (OFF) position, and pull out the landing gear circuit breaker. To stow the crank, push the lock release button on the crank handle, fold handle and insert it in the storage clip.

#### NOTE

The handcrank handle must be stowed in its clip before the gear will operate electrically. When the handle is placed in the operating position, it disengages the landing gear motor from the actuator gear.

The procedure for manually lowering the landing gear is given in Section III.

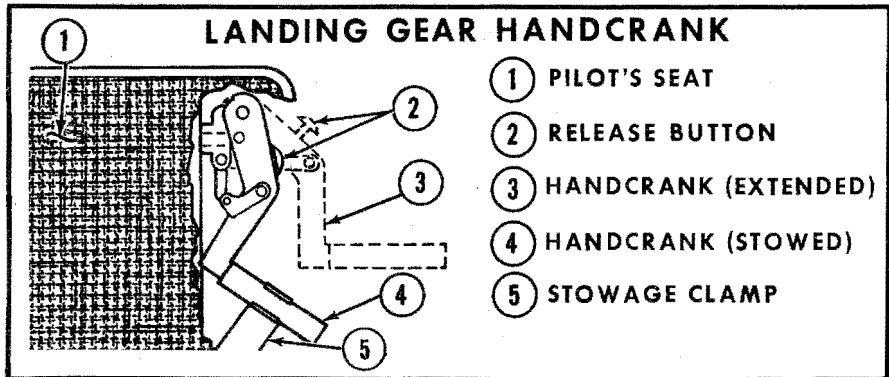

Figure 2-6

## HEATING, VENTILATING AND DEFROSTING SYSTEM

A cabin heating, ventilating and windshield defrosting system (Figure 2-7), is standard equipment in your aircraft. The system consists of an air inlet on the right side of the nose, a ventilating fan, a gasoline combustion-type heater, and controllable heat outlets in the cabin. Two outlets are located at the base of the windshield for defrosting purposes, one

# HEATING, VENTILATING AND DEFROST SYSTEM

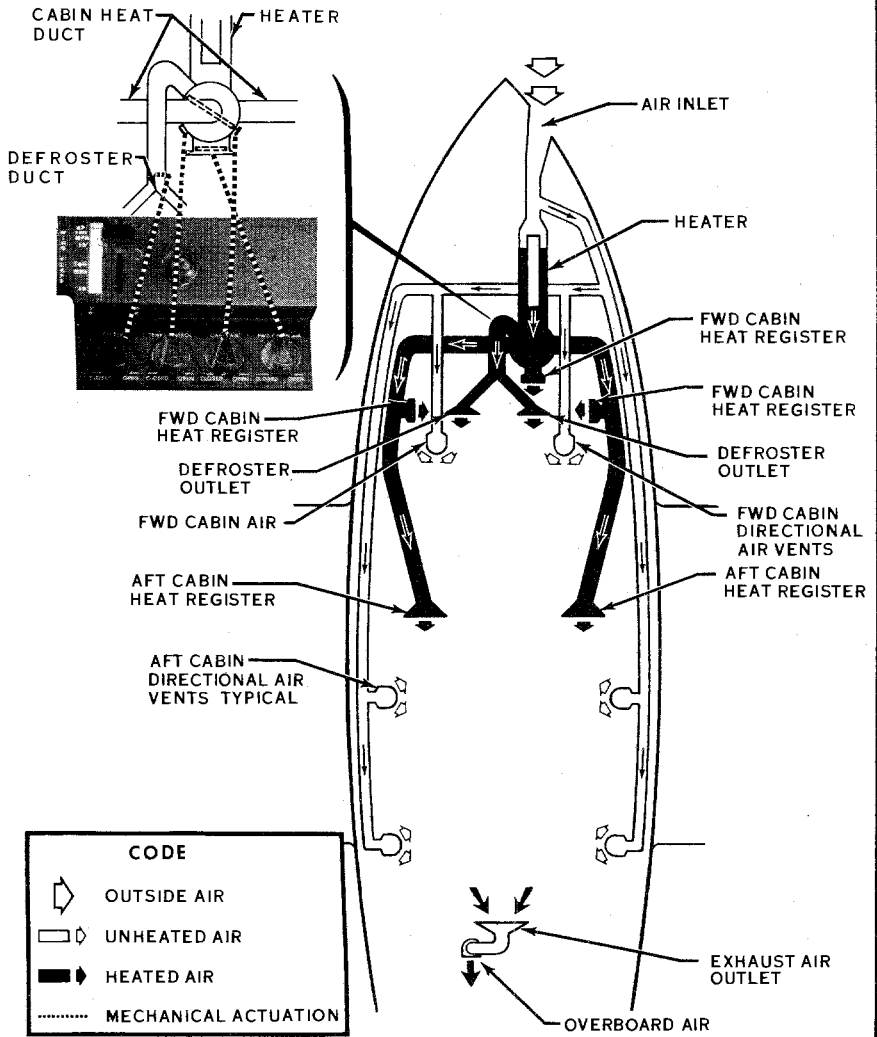

Figure 2-7

is located on the forward cabin bulkhead and one on each side of the forward cabin. Two additional outlets are located in the aft passenger compartment on the aft face of the main spar.

## **HEATING AND DEFROSTING**

Fresh air is picked up from the front opening in the nose of the aircraft, heated by the heater, and ducted to the pilot and passenger compartments. The heated and ventilating air is not recirculated, but exhausts overboard through a passenger compartment air outlet.

The cabin heater depends upon the aircraft fuel system for its fuel supply. Fuel pressure is supplied by a fuel pump mounted on the heater assembly; the main fuel system auxiliary fuel pumps need not be turned on for proper heater operation.

On the ground, the cabin heating system can be used for ventilation by placing the cabin fan switch in the CABIN FAN position. The fan provides unheated, fresh air to the cabin through the cabin heat registers. In flight, the fan becomes inoperative and the heating system can be used for ventilation by placing the cabin heat switch to the OFF position, turning the cabin air knobs to OPEN, and opening the heat registers as desired.

## **CABIN HEAT SWITCH**

The cabin heat switch is a two-position, center-off, toggle switch. Placing the switch in the HEAT position maintains cabin heater operation. Placing the switch in the FAN position provides ventilation for the cabin while the aircraft is on the ground.

## **CABIN AIR TEMPERATURE CONTROL KNOB**

The cabin air temperature control knob is labeled TEMP CONTROL, CLOSED (counterclockwise position), and OPEN (clockwise position).

Heater output is controlled by adjustment of the cabin air temperature control knob. This knob adjusts a thermostat, which in turn controls heated air temperature in a duct located just aft of the heater. When the temperature of the heated air exceeds the setting of the thermostat, the thermostat automatically opens and shuts off the heater. When the heated

air cools to the thermostat setting, the heater starts again. Thus, the heater continuously cycles on and off to maintain an even air temperature. The heater also will be cycled by a thermostatic switch in the cabin air duct, which shuts off the heater when the duct temperature reaches approximately 220° F. When the duct temperature drops to a normal operating level, the heater will restart automatically. The action of this switch is independent of the cabin thermostat setting, and is not adjustable in flight.

### **FORWARD CABIN AIR KNOB**

The forward cabin air knob control directs warm air to the outlet located on the forward cabin bulkhead. This direct outlet allows fast warm-up when the aircraft is on the ground. Airflow through the direct outlet is completely shut off when the knob is turned to CLOSED. The knob may be set at any intermediate position to regulate the quantity of air to the pilot's compartment.

### **CABIN AIR KNOB**

The airflow to all the heat registers in the passenger compartment is controlled by the CABIN AIR knob. When the knob is turned to OPEN, the air flows to the heat registers in the passenger compartment. Airflow to the heat registers is completely shut-off by turning the knob to CLOSED. The knob may be set in any intermediate position to regulate the quantity of air to the cabin.

### **CABIN HEAT REGISTERS**

Two cabin heat registers are located on the aft side of the main spar beneath the pilot's and copilot's seats and one on each side in the forward cabin. Each register is provided with a lever operated, rotary-type valve which controls the amount of air coming from the heat registers. Each register is plainly marked for open or closed and may be placed in any intermediate position to regulate the amount of air coming from the registers.

### **DEFROST KNOB**

Windshield defrosting and defogging is controlled by operating the knob labeled DEFROST. When the knob is turned to OPEN, the air flows from

the defroster outlets at the base of the windshield. When the knob is turned to CLOSED, airflow to the defroster outlets is shut off. The knob may be set in any intermediate position to regulate the defroster airflow.

## OVERHEAT WARNING LIGHT

An amber overheat warning light is provided and is labeled HEATER OVERHEAT. When illuminated, the light indicates that the heater overheat switch has been actuated and that the temperature of the air in the heater has exceeded 325° F. Once the heater overheat switch has been actuated, the heater turns off and cannot be restarted until the overheat switch, located in the right forward nose compartment, has been reset. Prior to having the overheat switch reset, the heater should be thoroughly checked to determine the reason for the malfunction.

## HEATER OPERATION FOR HEATING AND DEFROSTING

- (1) Battery Switch - ON.
- (2) Cabin Air Knob - OPEN.
- (3) Defrost Knob - Adjust as desired (if defrosting is desired).
- (4) Temperature Control Knob - OPEN.
- (5) Cabin Heat Switch - HEAT.
- (6) Heat Registers - As Desired.

Cabin heated air temperature may be increased during operation in extremely cold weather by manually adjusting the defrost, forward cabin and aft cabin air controls to reduce total airflow into the cabin.

### NOTE

- If warm air is not felt coming out of the registers within one minute, turn cabin heat switch OFF, check circuit breaker and try another start. If heater still does not start, no further starting attempt should be made.
- During heater operation, defrost and/or cabin air knobs must be open.



## HEATER USED FOR VENTILATION

- (1) Battery Switch - ON.
- (2) Cabin Air Knob - Open as desired.
- (3) Cabin Fan Switch - FAN.
- (4) Heat Registers - As desired.

## VENTILATING SYSTEM

In addition to the ventilation provided by the cabin heating system, a separate ventilation system obtains ram air from the air inlet just forward of the heater and ducts it to the directional vents. The ventilating system functions only in flight, since it depends entirely on ram air pressure. For ground ventilation, the ventilating fan of the heating system must be used.

## STATIC PRESSURE ALTERNATE SOURCE VALVE

A static pressure alternate source valve, installed in the static system, directly below the parking brake handle, supplies an alternate static source should the external source malfunction. This valve also permits draining condensate from the static lines. When open, this valve vents to the static pressure in the cabin. Since this pressure is relatively low, the airspeed indicator and the altimeter will show slightly higher readings than normal. Therefore, the alternate static source should be used primarily as a drain valve to restore the original system. If the alternate static source must be used during flight increase indicated airspeeds approximately 10 MPH and altitudes approximately 80 feet. Consult the pilot's checklist for an accurate calibration. If the dual heated pitot system is installed with or without the weather radar refer to Section VII for airspeed calibrations.

## PITOT HEAT SWITCH

When the pitot heat switch is placed in the ON position, the heating element in the pitot tube, stall warning transmitter and the main fuel tank vents are electrically heated to maintain proper operation of the system during icing conditions. The switch should always be in the OFF position while on the ground to prevent overheating of the heating elements.

## EMERGENCY EXIT

For emergency exit, the pilot's window (left side) can be jettisoned. Pull off the plastic cover over the emergency release ring under the window and pull the ring to release the window retainers, then push the window out.

## OVERHEAD CONSOLE

The overhead console, see Figure 2-8, includes the instrument panel light and control, avionics speaker and individual pilot and copilot jacks for headphones, microphones and oxygen.

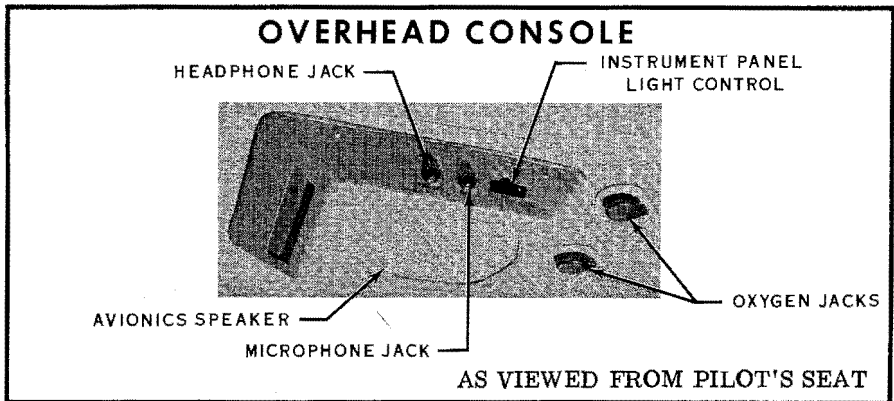

Figure 2-8

**ENGINE INOPERATIVE PROCEDURES****ENGINE FAILURE DURING TAKEOFF - SPEED BELOW 105 MPH IAS  
( With Sufficient Runway Remaining )**

- (1) Throttles - CLOSE immediately.
- (2) Brakes - AS REQUIRED.

**NOTE**

The distance required for the aircraft to be accelerated from a standing start to 105 MPH IAS on the ground, and then decelerate to a stop with heavy braking is presented in the Accelerate Stop Distance Chart in Section VI for various combinations of conditions.

**ENGINE FAILURE AFTER TAKEOFF - SPEED ABOVE 105 MPH IAS  
( Without Sufficient Runway Ahead )**

- (1) Mixture - AS REQUIRED for altitude.
- (2) Propellers - FULL FORWARD.
- (3) Throttles - FULL FORWARD.
- (4) Landing Gear - UP.
- (5) Determine inoperative engine (idle engine same side as idle foot).
- (6) Inoperative engine:
  - (a) Throttle - CLOSE.
  - (b) Mixture - IDLE CUT-OFF.
  - (c) Propeller - FEATHER.
- (7) Establish Bank - 5° toward operative engine.
- (8) Climb to Clear Obstacle - 105 MPH IAS.
- (9) Climb at Best Single-Engine Climb Speed - 116 MPH IAS.
- (10) Wing Flaps - UP (if extended) in small increments.
- (11) Trim Tabs - ADJUST 5° bank toward operative engine.

- (12) Inoperative Engine - SECURE.
  - (a) Fuel Selector - OFF.
  - (b) Auxiliary Fuel Pump - OFF.
  - (c) Magneto Switches - OFF.
  - (d) Alternator Switch - OFF.
- (13) As Soon as Practical - LAND.

### SUPPLEMENTARY INFORMATION CONCERNING ENGINE-OUT DURING TAKEOFF

The most critical time for an engine-out condition in a multi-engine aircraft is during a two or three second period late in the takeoff run while the aircraft is accelerating to a safe engine-failure speed. A detailed knowledge of recommended single-engine airspeeds, Figure 3-1, is essential for safe operation of this aircraft.

The airspeed indicator is marked with a red radial line at the minimum single-engine control speed and a blue radial line at the best single-engine rate-of-climb speed to facilitate instant recognition. The following paragraphs present a detailed discussion of the problems associated with engine failures during takeoff.

SINGLE-ENGINE AIRSPEED NOMENCLATURE	MPH - IAS
(1) Minimum Single-Engine Control Speed (red radial) . . . . .	86
(2) Recommended Safe Single-Engine Speed . . . . .	105
(3) Best Single-Engine Angle-of-Climb Speed . . . . .	108
(4) Best Single-Engine Rate-of-Climb Speed (Flaps Up) (blue radial) . . . . .	116

Figure 3-1

**MINIMUM SINGLE ENGINE CONTROL SPEED:** The twin-engine aircraft must reach the minimum control speed (86 MPH IAS) before full control deflections can counteract the adverse rolling and yawing tendencies associated with one engine inoperative and full power operation on the other engine. This speed is indicated by a red radial line on the airspeed indicator.

**RECOMMENDED SAFE SINGLE ENGINE SPEED.** Although the aircraft is controllable at the minimum control speed, the aircraft performance is so far below optimum that continued flight near the ground is improbable.

A more suitable recommended safe single-engine speed is 105 MPH IAS since at this speed, altitude can be maintained more easily while the landing gear is being retracted and the propeller is being feathered.

**BEST SINGLE-ENGINE ANGLE-OF-CLIMB SPEED.** The best angle-of-climb speed for single-engine operation becomes important when there are obstacles ahead on takeoff, because once the best single-engine angle-of-climb speed is reached, altitude becomes more important than air-speed until the obstacle is cleared. The best single-engine angle-of-climb speed is approximately 108 MPH IAS with flaps up.

**BEST SINGLE-ENGINE RATE-OF-CLIMB SPEED (FLAPS UP).** The best rate-of-climb speed for single-engine operation becomes important when there are no obstacles ahead on takeoff, or when it is difficult to maintain or gain altitude in single-engine emergencies. The best single-engine rate-of-climb speed is 116 MPH IAS with flaps up. This speed is indicated by a blue radial line on the airspeed indicator. The variation of flaps-up best rate-of-climb speed with altitude is shown in Section VI. For best climb performance, the wings should be banked  $5^{\circ}$  toward the operative engine.

Upon engine failure after reaching 105 MPH IAS on takeoff, the multi-engine pilot has a significant advantage over a single-engine pilot, for he has the choice of stopping or continuing the takeoff. This would be similar to the choice forcing a single-engine pilot who has suddenly lost slightly more than half of his takeoff power. In this situation, the single-engine pilot would be extremely reluctant to continue the takeoff if he had to climb over obstructions. However, if the failure occurred at an altitude as high or higher than surrounding obstructions, he would feel free to maneuver for a landing back at the airport.

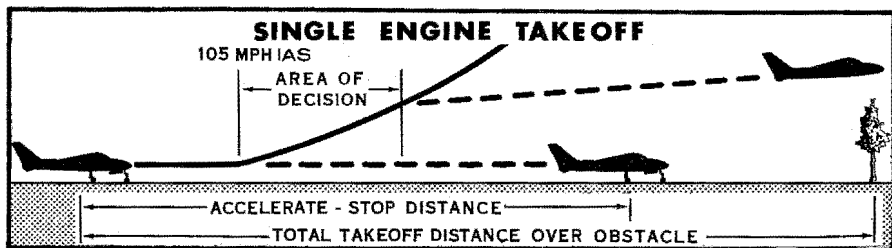

Figure 3-2

Fortunately the aircraft accelerates through this "area of decision" in just a few seconds. However, to make an intelligent decision in this type of an emergency, one must consider the field length, obstruction height, field elevation, air temperature, headwind, and the gross weight. The flight paths illustrated in Figure 3-2 indicate that the "area of decision" is bounded by: (1) the point at which 105 MPH IAS is reached and (2) the point where the obstruction altitude is reached. An engine failure in this area requires an immediate decision. Beyond this area, the aircraft, within the limitations of single-engine climb performance shown in Section VI, may be maneuvered to a landing back at the airport.

At sea level standard day with zero wind and 5300 pounds gross weight, the distance to accelerate to 105 MPH IAS and stop is 3400 feet, while the total unobstructed area required to takeoff and climb over a 50 foot obstacle after an engine failure at 105 MPH IAS is 4600 feet. This total distance over an obstacle can be reduced slightly under more favorable conditions of gross weight, headwind, or obstruction height. However, it is recommended that in most cases it would be better to discontinue the takeoff, since any slight mismanagement of the single-engine procedure would more than offset the small distance advantage offered by continuing the takeoff. The advantage of discontinuing the takeoff is even more obvious at higher altitudes where the corresponding distances are 3850 and 8340 respectively, at 2000 feet. Still higher field elevations will cause the single-engine takeoff distance to lengthen disproportionately until an altitude is reached where a successful takeoff is improbable unless the airspeed and height above the runway at engine failure are great enough to allow a slight deceleration and altitude loss while the aircraft is being prepared for a single-engine climb.

During single-engine takeoff procedures over an obstacle, only one condition presents any appreciable advantage; this is headwind. A decrease of approximately 1% in ground distance required to clear a 50-foot obstacle can be gained for each 1 MPH of headwind. Excessive speed above best single-engine climb speed at engine failure is not nearly as advantageous as one might expect since deceleration is rapid and ground distance is used up quickly at higher speeds while the aircraft is being cleaned up for climb. However, the extra speed is important for controllability.

The following facts should be used as a guide at the time of engine failure: (1) discontinuing a takeoff upon engine failure is advisable under most circumstances; (2) altitude is more valuable to safety after takeoff than is airspeed in excess of the best single-engine climb speed since excess airspeed is lost much more rapidly than is altitude; (3) climb or con-

# RPM TO SIMULATE CRITICAL (LEFT) ENGINE FEATHERED

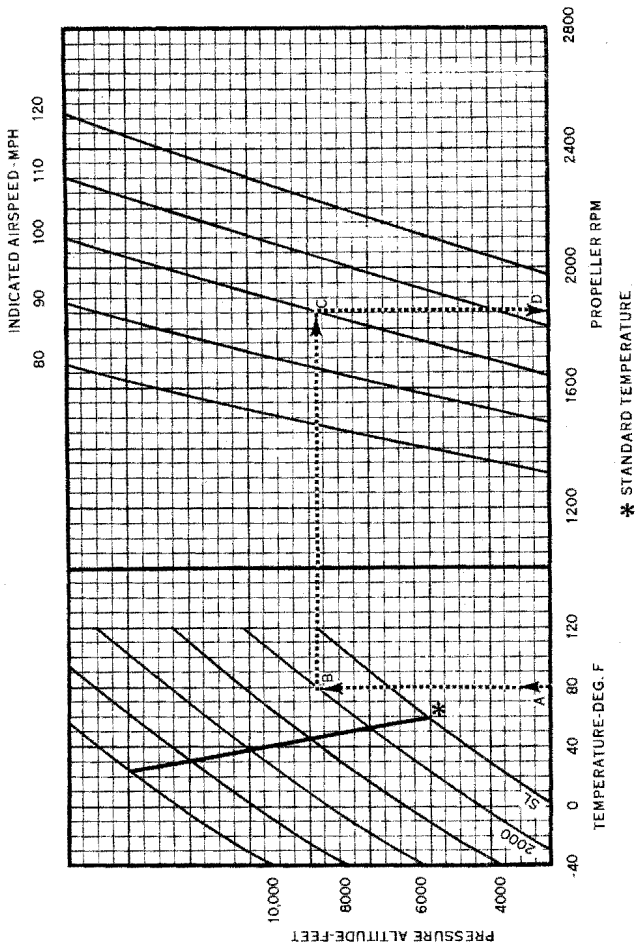

**CONDITIONS:**

1. Propeller Control Full High RPM - Full Low Pitch
2. Manifold Pressure Adjusted to Obtain Proper RPM.

**EXAMPLE:**

- A. Temperature - 80° F.
- B. Pressure Altitude - 2000 Ft.
- C. Airspeed - 100 MPH IAS.
- D. Propeller Speed - 1855 RPM.

Figure 3-3

tinued level flight at moderate altitude is improbable with the landing gear extended and the propeller windmilling; (4) in no case should the airspeed be allowed to fall below the engine-out best angle-of-climb speed, even though altitude is lost, since this speed will always provide a better chance of climb, or a smaller altitude loss, than any lesser speed. The single-engine best rate-of-climb speed will provide the best chance of climb or the least altitude loss, and is preferable unless there are obstructions which make a steep climb necessary.

Single-engine procedures should be practiced in anticipation of an emergency. This practice should be conducted at a safe altitude, with full power operation on both engines, and should be started at a safe speed of at least 120 MPH IAS. As recovery ability is gained with practice, the starting speed may be lowered in small increments until the feel of the aircraft in emergency conditions is well known. Practice should be continued until: (1) an instinctive corrective reaction is developed, and the corrective procedure is automatic; and (2) airspeed, altitude, and heading can be maintained easily while the aircraft is being prepared for a climb. In order to simulate an engine failure, set both engines at full power operation, then at a chosen speed, pull the mixture control of one engine into IDLE CUT-OFF, and proceed with single-engine emergency procedures. Simulated single-engine procedures can also be practiced by setting propeller RPM to simulate critical engine inoperative as shown in Figure 3-3.

## **ENGINE FAILURE DURING FLIGHT**

- (1) Determine inoperative engine (idle engine same side as idle foot).
- (2) Power - INCREASE as required.
- (3) Mixture - ADJUST for altitude.

Before securing inoperative engine:

- (4) Fuel Flow - CHECK, if deficient, position auxiliary fuel pump switch to ON.

### **NOTE**

If fuel selector valve is in AUXILIARY TANK position, switch to MAIN TANK and feel for detent.



- (5) Fuel Quantity - CHECK, and switch to opposite MAIN TANK if necessary.
- (6) Oil Pressure and Oil Temperature - CHECK, shutdown engine if oil pressure is low.
- (7) Magneto Switches - CHECK.

If proper corrective action was taken, engine will restart. If it does not, secure as follows:

- (8) Inoperative Engine - SECURE.
  - (a) Throttle - CLOSED.
  - (b) Mixture - IDLE CUT-OFF.
  - (c) Propeller - FEATHER.
  - (d) Fuel Selector - OFF.
  - (e) Auxiliary Fuel Pump - OFF.
  - (f) Magneto Switches - OFF.
  - (g) Alternator Switch - OFF.
- (9) Operative Engine - ADJUST.
  - (a) Power - AS REQUIRED.
  - (b) Mixture - ADJUST for power.
  - (c) Fuel Selector - MAIN TANK (feel for detent).
  - (d) Auxiliary Fuel Pump - ON.
- (10) Trim Tabs - ADJUST (5° bank toward operative engine).
- (11) Electrical Load - DECREASE to maintain a positive ammeter reading.
- (12) As Soon as Practical - LAND.

## ENGINE FIRE PROCEDURE

### ON THE GROUND

- (1) Throttles - CLOSE immediately.
- (2) Brakes - AS REQUIRED.
- (3) Mixtures - IDLE CUT-OFF.
- (4) Fuel Selectors - OFF.
- (5) Battery Switch - OFF.
- (6) Magnetos - OFF.
- (7) Evacuate aircraft as soon as practical.

## **IN FLIGHT (Appropriate Engine)**

- (1) Throttle - CLOSE.
- (2) Mixture - IDLE CUT-OFF.
- (3) Propeller - FEATHER.
- (4) Fuel Selector - OFF.
- (5) Auxiliary Fuel Pump - OFF.
- (6) Engine - SECURE.
- (7) If fire persists - LAND as soon as possible.
- (8) If fire goes out, CONTINUE according to engine inoperative procedures.

## **ENGINE RESTARTS IN FLIGHT (After Feathering)**

### **AIRCRAFT WITHOUT OPTIONAL PROPELLER UNFEATHERING SYSTEM INSTALLED**

- (1) Magneto Switches - ON.
- (2) Throttle - FORWARD approximately one inch.
- (3) Propeller - FORWARD of detent.
- (4) Mixture - FULL RICH.
- (5) Fuel Selector - MAIN TANK (feel for detent).
- (6) Starter Button - PRESS.
- (7) Primer Switch - ACTIVATE.
- (8) Starter Switch and Primer Switch - RELEASE when engine fires.
- (9) Power INCREASE slowly until cylinder head temperature reaches 200° F.

#### **NOTE**

If start is unsuccessful, turn magneto switches OFF, retard mixture to IDLE CUT-OFF, open throttle fully, and engage starter for several revolutions. Then repeat air start procedures.

## **AIRCRAFT WITH OPTIONAL PROPELLER UNFEATHERING SYSTEM INSTALLED**

- (1) Fuel Selector - MAIN TANK (feel for detent).
- (2) Magneto Switches - ON.
- (3) Throttle - FORWARD approximately one inch.
- (4) Mixture - FULL RICH.
- (5) Propeller - FULL FORWARD.

### **NOTE**

The propeller will automatically windmill when the propeller lever is moved out of the FEATHER position.

- (6) Propeller - RETARD to detent when propeller reaches 1000 RPM.

## **MAXIMUM GLIDE**

In the event of a double engine-failure condition, maximum gliding distance can be obtained by feathering both propellers, and maintaining approximately 111 MPH IAS with the landing gear and wing flaps up. Refer to the Maximum Glide Diagram, Figure 3-4, for maximum glide data.

## **SINGLE-ENGINE APPROACH AND LANDING**

- (1) Mixture - FULL RICH.
- (2) Propeller - FULL FORWARD.
- (3) Approach at 108 MPH IAS with excessive altitude.
- (4) Landing Gear - DOWN within glide distance of field.
- (5) Wing Flaps - DOWN when landing is assured.
- (6) Decrease speed below 103 MPH IAS only when landing is assured.
- (7) Minimum Single-Engine Control Speed - 86 MPH IAS.

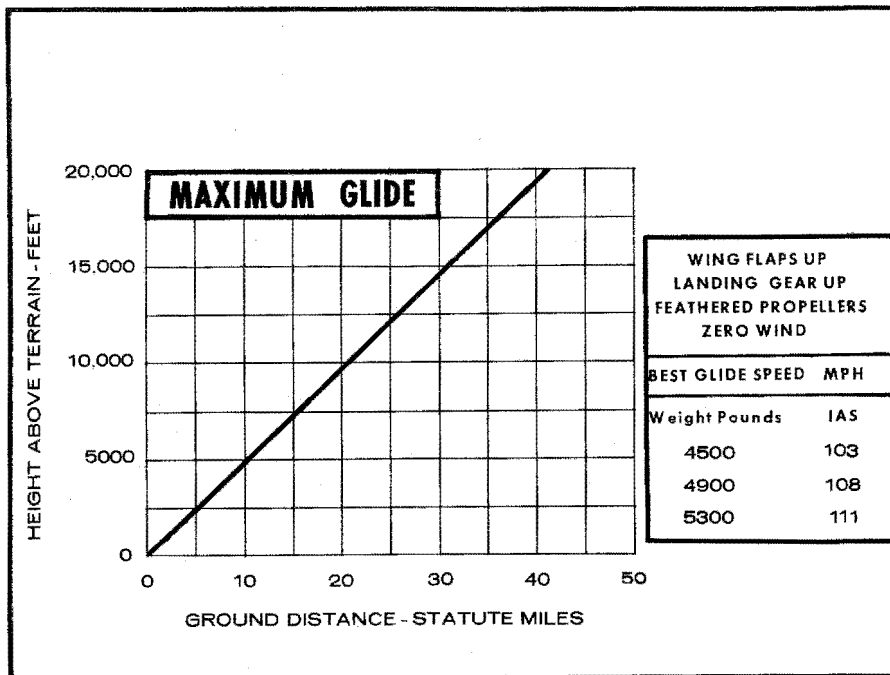

Figure 3-4

## FORCED LANDING

### (Precautionary Landing with Power)

- (1) Drag over selected field with flaps 15° and 105 MPH IAS noting type of terrain and obstructions.
- (2) Plan a wheels-down landing if surface is smooth and hard (pasture, frozen lake, etc.).

- (3) Execute a normal short-field landing, keeping nosewheel off ground until speed is decreased.
- (4) If terrain is rough or soft, plan a wheels-up landing as follows:
  - (a) Select a smooth grass-covered runway, if possible.
  - (b) Landing Gear Switch - UP.
  - (c) Approach at 103 MPH IAS with flaps down only 15°
  - (d) All Switches Except Magneto Switches - OFF.
  - (e) Unlatch cabin door prior to flare-out.

**NOTE**

Be prepared for a mild tail buffet as the cabin door is opened.

- (f) Mixtures - IDLE CUT-OFF (both engines).
- (g) Magneto Switches - OFF.
- (h) Fuel Selectors - OFF.
- (i) Land in a slightly tail-low attitude.

**NOTE**

Aircraft will slide straight ahead about 500 feet on smooth sod with very little damage.

## **FORCED LANDING (Complete Power Loss)**

- (1) Mixtures - IDLE CUT-OFF.
- (2) Propellers - FEATHER then rotate to HORIZONTAL position with starter if time permits.
- (3) Fuel Selectors - OFF.
- (4) All Switches Except Battery Switch - OFF.
- (5) Approach at 108 MPH IAS.
- (6) If field is smooth and hard, plan a landing as follows:
  - (a) Landing Gear - DOWN within glide distance of field.
  - (b) Wing Flaps - EXTEND as necessary when within glide distance of field.
  - (c) Battery Switch - OFF.

- (d) Make a normal landing, keeping nosewheel off the ground as long as practical.
- (7) If field is rough or soft, plan a wheels-up landing as follows:
  - (a) Select a smooth, grass-covered runway if possible.
  - (b) Landing Gear - UP.
  - (c) Approach at 105 MPH IAS with flaps down only 15°.
  - (d) Battery Switch - OFF.
  - (e) Unlatch cabin door prior to flare-out.

#### NOTE

Be prepared for a mild tail buffet as cabin door is opened.

- (f) Land in a slightly tail-low attitude.

## GO-AROUND (SINGLE-ENGINE)

- (1) If absolutely necessary and speed is above 105 MPH, increase engine speed to 2625 RPM and apply full throttle.
- (2) Landing Gear - UP.
- (3) Flaps - UP (if extended).
- (4) Climb at 116 MPH IAS (108 MPH IAS with obstacles directly ahead).
- (5) Trim aircraft for single-engine climb.

## SYSTEM EMERGENCY PROCEDURES

### FUEL SYSTEM

#### ENGINE DRIVEN INJECTOR PUMP FAILURE

- (1) Fuel Selector - MAIN TANK (feel for detent).
- (2) Auxiliary Fuel Pump - ON.
- (3) Mixture - FULL RICH.

- (4) As Soon As Practical - LAND.
- (5) Fuel in Auxiliary and Opposite Main Tank is Unusable.

#### NOTE

If both an engine-driven fuel pump and an auxiliary fuel pump fail on the same side of the aircraft, the failing engine cannot be supplied with fuel from the opposite MAIN tank since that auxiliary fuel pump will operate on the low pressure setting as long as the corresponding engine fuel pump is operative.

## ELECTRICAL SYSTEM

### ALTERNATOR FAILURE (Single) (Indicated by illumination of failure light)

- (1) Electrical Load - REDUCE.
- (2) If circuit breaker is tripped.
  - (a) Shut off affected alternator.
  - (b) Reset affected alternator circuit breaker.
  - (c) Turn on affected alternator switch.
  - (d) If circuit breaker reopens, turn off alternator.
- (3) If circuit breaker does not trip.
  - (a) Select affected alternator on ammeter and monitor output.
  - (b) If output is normal and failure light remains on, disregard fail indication and have indicator checked after landing.
  - (c) If output is insufficient turn off alternator and reduce electrical load to one alternator capacity.
  - (d) If complete loss of alternator output occurs check field fuse and replace if necessary. Spare fuses are located in the glove box.
  - (e) If an intermittent light indication accompanied by ammeter fluctuation is observed - shut off affected alternator and reduce load to one alternator capacity.

## **ALTERNATOR FAILURE (Dual)**

(Indicated by illumination of failure lights)

- (1) Electrical Load - REDUCE.
- (2) If circuit breakers are tripped.
  - (a) Shut off alternators.
  - (b) Reset circuit breakers.
  - (c) Turn on alternators.
  - (d) If circuit breakers reopen prepare to terminate flight.
- (3) If circuit breakers have not tripped.
  - (a) Check field fuses and replace as required. Spare fuses are located in the glove box.
  - (b) If still inoperative turn off right alternator and turn on emergency alternator field switch
  - (c) If still inoperative turn off left alternator and turn on right alternator.
  - (d) If still inoperative turn off alternators and prepare to terminate flight.

### **NOTE**

The stall warning system is inoperative when the battery switch is in the "OFF" position.

## **FLIGHT INSTRUMENTS**

### **OBSTRUCTION OR ICING OF STATIC SOURCE**

- (1) Alternate Static Source - OPEN.
- (2) Excess Altitude and Airspeed - MAINTAIN to compensate for change in calibration. Increase indicated airspeed approximately 10 MPH and altitudes approximately 80 feet. Refer to Pilot's Checklist for accurate calibration.

### **NOTE**

Be sure the alternate static source is closed for all normal operations.



## VACUUM PUMP FAILURE

- (1) Red indicator on gage will show failure.
- (2) Automatic valve will select operative source.

## ELECTRIC DIRECTIONAL GYRO

If optional electric gyro is installed:

- (1) If gyro power fail light illuminates, position gyro power switch to STANDBY.
- (2) If light does not go out, check gyro circuit breaker - IN.

## LANDING GEAR SYSTEM

### LANDING GEAR WILL NOT EXTEND ELECTRICALLY

When the landing gear will not extend electrically, it may be extended manually in accordance with the following steps:

#### NOTE

The handcrank handle must be stowed in its clip before the gear will operate electrically. When the handle is placed in the operating position, it disengages the landing gear motor from the actuator gear.

- (1) Before proceeding manually, check landing gear circuit breakers with landing gear switch DOWN. If circuit breakers are tripped, allow 3 minutes for them to cool before resetting.
- (2) If Circuit Breaker is Not Tripped - PULL.
- (3) Landing Gear Switch - NEUTRAL (center).
- (4) Pilot's Seat - TILT full aft (std) or RAISE (opt).
- (5) Hand Crank - EXTEND AND LOCK. (See Figure 2-6).
- (6) Rotate Crank - CLOCKWISE four turns past point where gear down lights come on (approximately 52 turns).

#### NOTE

During manual extension of the gear, never release the hand crank to let it turn freely of its own accord.

- (7) Gear Down Lights - CHECK.
- (8) Gear Unlocked Light - CHECK.
- (9) Gear Warning Horn - CHECK with throttle retarded.
- (10) Hand Crank - PUSH BUTTON and STOW.
- (11) As Soon As Practical - LAND.

#### LANDING GEAR WILL NOT RETRACT ELECTRICALLY

- (1) Do not try to retract manually.

#### NOTE

The landing gear should never be retracted with the manual system, as undue loads will be imposed and cause excessive wear on the cranking mechanism.

- (2) Landing Gear - DOWN.
- (3) Gear-Down Lights - CHECK.
- (4) Gear Unlocked Light - CHECK.
- (5) Gear Warning Horn - CHECK.
- (6) As Soon As Practical - LAND.

#### AIR INLET OR FILTER ICING

- (1) Alternate Air Controls - PULL OUT.
- (2) Propellers - INCREASE (2550 RPM for normal cruise).
- (3) Mixtures - LEAN as required.

# LANDING EMERGENCIES

## LANDING WITH FLAT MAIN GEAR TIRE

If a blowout occurs during takeoff, and the defective main gear tire is identified, proceed as follows:

- (1) Landing Gear - UP.
- (2) Fuel Selectors - Turn to main tank on same side as defective tire and feel for detent. Proceed to destination to reduce fuel load.

### NOTE

Fuel should be used from this tank first to lighten the load on this wing prior to attempting a landing, if in-flight time permits. However, an adequate supply of fuel should be left in this tank so that it may be used during landing.

- (3) Fuel Selectors - Left Engine - LEFT MAIN (feel for detent).  
Right Engine - RIGHT MAIN (feel for detent).
- (4) Select a runway with a crosswind from the side opposite the defective tire, if a crosswind landing is required.
- (5) Landing Gear Switch - DOWN (below 160 MPH CAS).
- (6) Check landing gear down indicator lights (green) for indication and gear unlocked light (red) out.
- (7) Flaps - DOWN. Fully extend flaps to 35°.
- (8) In approach, align aircraft with edge of runway opposite the defective tire, allowing room for a mild turn in the landing roll.
- (9) Land slightly wing-low on side of inflated tire and lower nose-wheel to ground immediately, for positive steering.
- (10) Use full aileron in landing roll, to lighten load on defective tire.
- (11) Apply brake only on the inflated tire, to minimize landing roll and maintain directional control.
- (12) Stop aircraft to avoid further damage, unless active runway must be cleared for other traffic.

## LANDING WITH FLAT NOSE GEAR TIRE

If a blowout occurs on the nose gear tire during takeoff, prepare for a landing as follows:

- (1) Landing Gear - Leave DOWN.

### NOTE

Do not attempt to retract the landing gear if a nose gear tire blowout occurs. The nose gear tire may be distorted enough to bind the nosewheel strut within the wheel well and prevent later gear extension.

- (2) Move disposable load to baggage area and passengers to available rear seat space.
- (3) Flaps - DOWN. Extend flaps from  $0^{\circ}$  to  $15^{\circ}$ , as desired.
- (4) Land in a nose-high attitude with or without power.
- (5) Maintain back pressure on control wheel to hold nosewheel off the ground in landing roll.
- (6) Use minimum braking in landing roll.
- (7) Throttles - RETARD in landing roll.
- (8) As landing roll speed diminishes, hold control wheel fully aft until aircraft is stopped.
- (9) Avoid further tire damage by holding additional taxi to a minimum.

## LANDING WITH DEFECTIVE MAIN GEAR

Reduce the fuel load in the tank on the side of the faulty main gear as explained in paragraph LANDING WITH FLAT MAIN GEAR TIRE. When fuel load is reduced, prepare to land as follows:

- (1) Fuel Selectors - Left Engine - LEFT MAIN (feel for detent).  
Right Engine - RIGHT MAIN (feel for detent).
- (2) Select a wide, hard surface runway, or if necessary a wide sod runway. Select a runway with crosswind from the side opposite the defective landing gear, if a crosswind landing is necessary.
- (3) Landing Gear - DOWN.

- (4) Flaps - DOWN.
- (5) In approach, align aircraft with edge of runway opposite the defective landing gear, allowing room for a ground-loop in landing roll.
- (6) Battery Switch - OFF.
- (7) Land slightly wing-low toward the operative landing gear and lower the nosewheel immediately, for positive steering.
- (8) Start moderate ground-loop toward defective landing gear until aircraft stops.
- (9) Mixtures - IDLE CUT-OFF (both engines).
- (10) Use full aileron in landing roll to lighten the load on the defective landing gear.
- (11) Apply brake only on the operative landing gear to maintain directional control and minimize the landing roll.
- (12) Fuel Selectors - OFF.
- (13) Evacuate the aircraft as soon as it stops.

## **LANDING WITH DEFECTIVE NOSE GEAR**

### **Sod-Runway—Main Gear Retracted**

This procedure will produce a minimum amount of aircraft damage on smooth runways. This procedure is also recommended for short, rough, or uncertain field conditions where passenger safety, rather than minimum aircraft damage, is the prime consideration.

- (1) Select a smooth, grass-covered runway, if possible.
- (2) Landing Gear - UP.
- (3) Approach at 108 MPH IAS with flaps down only 15°.
- (4) All Switches Except Magneto Switches - OFF.
- (5) Unlatch cabin door prior to flare-out.

#### **NOTE**

Be prepared for mild tail buffet as the cabin door is opened.

- (6) Land in a slightly tail-low attitude.
- (7) Mixtures - IDLE CUT-OFF (both engines).
- (8) Magneto Switches - OFF.
- (9) Fuel Selectors - OFF.

### **Smooth Hard Surface Runway—Main Gear Extended**

- (1) Move disposable load to baggage area, and passengers to available rear seat space.
- (2) Select a smooth, hard surface runway.
- (3) Landing Gear - DOWN.
- (4) Approach at 108 MPH IAS with flaps down only 15°.
- (5) All Switches Except Magneto Switches - OFF.
- (6) Land in a slightly tail-low attitude.
- (7) Mixtures - IDLE CUT-OFF (both engines).
- (8) Magneto Switches - OFF.
- (9) Hold nose off throughout ground roll - Lower gently as speed dissipates.

### **DITCHING**

- (1) Plan approach into wind, if winds are high and seas are heavy. With heavy swells and light wind, land parallel to swells, being careful not to allow wing tip to hit first.
- (2) Approach with landing gear retracted, flaps 35°, and enough power to maintain approximately 300 ft/min. rate-of-descent at approximately 109 MPH IAS at 4600 pounds gross weight.
- (3) Maintain a continuous descent until touchdown, to avoid flaring and touching down tail-first, pitching forward sharply, and decelerating rapidly. Strive for initial contact at fuselage area below rear cabin section (point of maximum longitudinal curvature of fuselage).

---

## OPERATIONS AUTHORIZED

Your Cessna with standard equipment, exceeds the requirements of airworthiness as set forth by the United States Government, and is certified under FAA Type Certificate No. 3A10.

With standard equipment, the aircraft is approved for day and night operation under VFR. Additional optional equipment is available to increase its utility and to make it authorized for use under IFR day and night operation. Your Cessna Dealer will be happy to assist you in selecting equipment best suited to your needs.

## MANEUVERS-NORMAL CATEGORY

The aircraft exceeds the requirements of the Federal Aviation Regulations, set forth by the United States Government for airworthiness. Spins and aerobatic maneuvers are not permitted in normal category aircraft in compliance with these regulations. In connection with the foregoing, the following gross weight and flight load factors apply:

Maximum Takeoff Weight . . . . .	5300 lbs.
Maximum Landing Weight . . . . .	5300 lbs.
*Flight Load Factor (at design gross weight)	
Flaps UP . . . . .	+3.8G
	-1.52G
Flaps DOWN . . . . .	+2.0G

\*The design load factors are 150% of the above and in all cases the structure exceeds design loads.

Your aircraft must be operated in accordance with all FAA approved marking, placards, and checklists in the aircraft. If there is any information in this section that contradicts the FAA approved markings, placards, and checklists, it is to be disregarded.

## AIRSPEED LIMITATIONS (CAS)

Maximum Structural Cruising Speed	
Level Flight or Climb . . . . .	210 MPH
Maximum Speed	
Flaps Extended 15° . . . . .	180 MPH
Flaps Extended 15° - 35° . . . . .	160 MPH
Gear Extended . . . . .	160 MPH
Never Exceed Speed (glide or dive, smooth air)	257 MPH
* Maneuvering Speed . . . . .	170 MPH

\*The maximum speed at which you can use abrupt control travel.

## AIRSPEED INDICATOR INSTRUMENT MARKINGS

The following is a list of the certificated calibrated airspeed (CAS) limitations for the aircraft.

Never Exceed (glide or dive, smooth air) . . . . .	257 MPH (red line)
Caution Range . . . . .	210-257 MPH (yellow arc)
Normal Operating Range . . . . .	86-210 MPH (green arc)
Flap Operating Range . . . . .	73.5-160 MPH (white arc)
Minimum Control Speed . . . . .	86 MPH (red radial line)
Best Single-Engine Rate of Climb . . . . .	117 MPH (blue radial line)

## ENGINE OPERATION LIMITATIONS

Maximum Power and Speed . . . . .	260 BHP at 2625 RPM
(for all operations)	

## ENGINE INSTRUMENT MARKINGS

### OIL TEMPERATURE GAGES

Normal Operating Range . . . . .	75° to 240° F (green arc)
Maximum Temperature . . . . .	240° F (red line)

### OIL PRESSURE GAGES

Idling Pressure . . . . .	10 PSI (red line)
Normal Operating Range . . . . .	30 to 60 PSI (green arc)
Maximum Pressure . . . . .	100 PSI (red line)



## CYLINDER HEAD TEMPERATURE

Normal Operating Range . . . . . 200° to 460° F (green arc)  
Maximum Temperature . . . . . 460° F (red line)

## MANIFOLD PRESSURE

Normal Operating Range . . . . . 15 to 24 inches Hg. (green arc)

## TACHOMETER

Normal Operating Range . . . . . 2100 to 2450 RPM (green arc)  
Maximum Engine Rated Speed . . . . . 2625 RPM (red line)

## FUEL FLOW

Normal Operating Range . . . . . 0 to 138 Lbs/Hr (green arc)  
Minimum and Maximum Fuel Flows . . . . . 0 and 138 Lbs/Hr (red line)  
3.8 and 20.10 PSI (red line)

## WING LOCKERS

The wing lockers are intended primarily for low density items, such as luggage and briefcases. The floor of the wing lockers, in particular, is primary structure, therefore, care should be exercised during loading and unloading to prevent damage. When loading high density objects, insure that adequate protection is available to prevent damage to any aircraft primary structure.

## LUGGAGE TIE-DOWN

Two hundred pounds of luggage is allowed at Station 96 behind the standard 310 seats without the use of luggage tie-downs. Any luggage stored at Station 96, with the individual seats installed will require luggage tie-downs. Luggage tie-downs for Station 96 are directly forward and directly aft of the Station 96 area. In all seating arrangements, stanchions or optional, luggage at Station 124 is limited to 160 lbs. and must be secured by luggage tie-downs. These luggage tie-downs are directly aft of the Station 96 luggage area and directly aft of the Station 124 luggage area. It is not recommended that any of the luggage tie-

downs extend from the aft side of Station 124 to the forward side of Station 96.

## **WEIGHT AND BALANCE**

The following information will enable you to operate your Cessna within the prescribed weight and center of gravity limitations. To figure the weight and balance for your particular aircraft, use figures 4-1, 4-2 and 4-3 as follows:

Take the licensed Empty Weight and Moment/1000 from the Weight and Balance Data sheet, plus any changes noted on forms FAA-337, carried in your aircraft, and write them down in the proper columns of figure 4-1. Using figure 4-2, determine the moment/1000 of each item to be carried. Total the weights and moments/1000 and use figure 4-3 to determine whether the point falls within the envelope and if the loading is acceptable.

<i>SAMPLE PROBLEM</i>	Sample Aircraft		Your Aircraft	
	Weight (lbs)	Moment (lb-ins.)	Weight (lbs)	Moment (lb-ins.)
1. Licensed Empty Weight (Sample Problem)	3411.0	121.9		
2. Oil *(24 Qts x 1.875 lb/qt)	45.0	-0.2	45.0	-0.2
3. Pilot and Passenger	340.0	12.6		
4. 6 Place Option (Center Seating) (Aft Seating)	340.0 340.0	23.1 33.3		
5. Fuel (gals. x 6 lbs/gal) Main Tanks (100 gals) Auxiliary Tanks (40 gals) Auxiliary Tanks (63 gals) Wing Locker Tanks (40 gals)	600.0 124.0	21.0 5.8		
6. Baggage (Sta. 96.0) (124.0) (Wing Lockers)	100.0	6.3		
7. Total Aircraft Weight (Loaded)	5300.0	223.8		
8. Locate this point (5300 at 223.8) on Figure 4-3 and since this point falls within the envelope, the loading is acceptable.				
*Note: Normally full oil may be assumed for all flights.				

Figure 4-1

# LOADING CHART

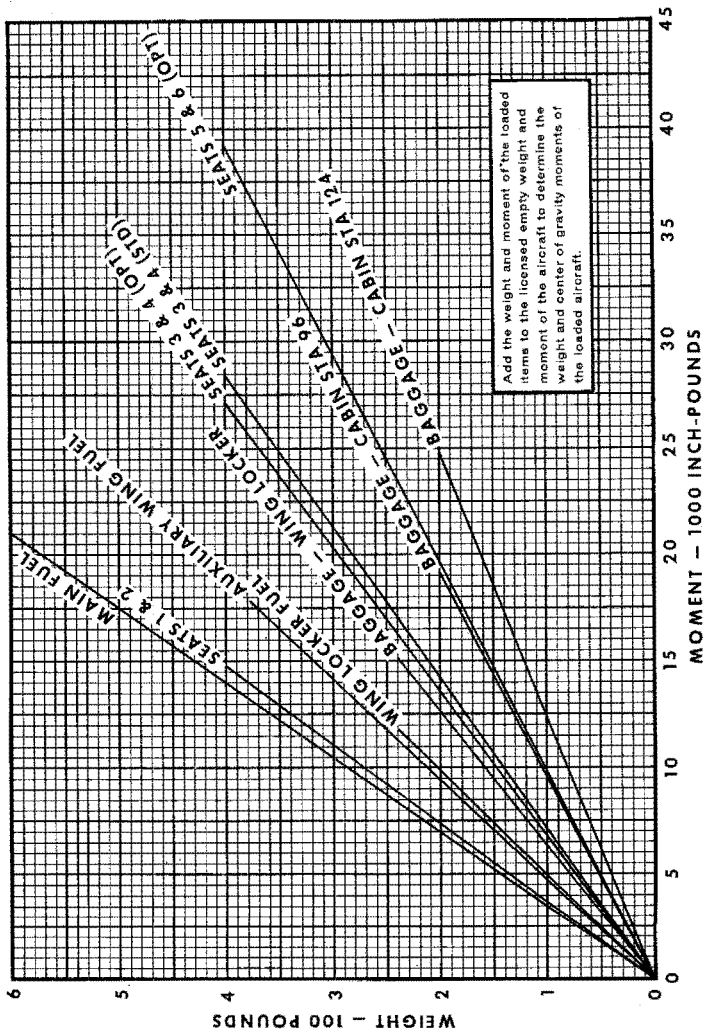

Figure 4-2

# CENTER OF GRAVITY MOMENT ENVELOPE

SAMPLE PROBLEM  
POINT  
5300.0, 223.8

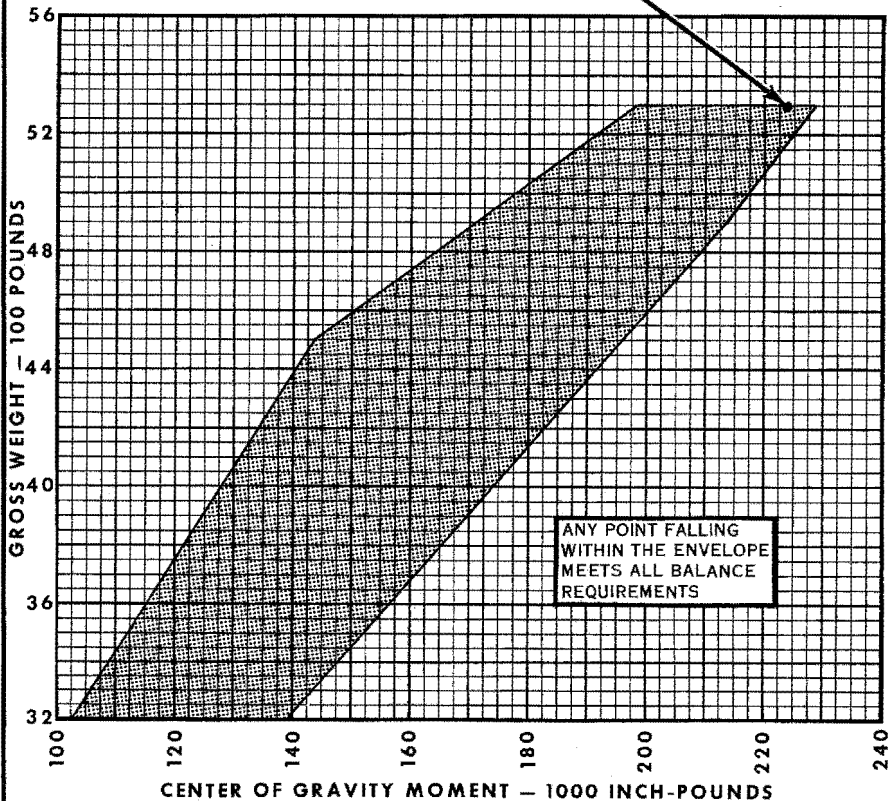

Figure 4-3

*Notes* .....

---

If your aircraft is to retain that new-plane performance and dependability, certain inspection and maintenance requirements must be followed. It is wise to follow a planned schedule of lubrication and preventive maintenance based on climatic and flying conditions encountered in your locality.

Keep in touch with your Cessna Dealer, and take advantage of his knowledge and experience. He knows your aircraft and how to maintain it. He will remind you when lubrications and oil changes are necessary, and about other seasonal and periodic services.

## **MAA IDENTIFICATION PLATE**

All correspondence concerning your Cessna should include the aircraft model and serial number. This information may be obtained from the FAR required MAA (Manufactures Aircraft Association) plate located on the main cabin door forward post. Refer to the aircraft Service Manual for an illustrated breakdown of the MAA plate.

## **GROUND HANDLING**

The aircraft should be moved on the ground with the aid of the nose wheel towing bar provided with each aircraft. The tow bar is designed to attach to the nose gear strut fork. Do not tow by tail tie-down fitting.

### NOTE

Remove all rudder locks before ground handling to prevent possible damage to the rudder interconnect pulley bracket. When using the tow bar, never exceed the nose wheel turning radius limits of 55° either side of center. Structural damage may occur if the turn limits are exceeded. Do not push or pull on propellers or control surfaces when moving the aircraft on the ground.

## MOORING YOUR AIRCRAFT

Proper tie-down procedure is your best precaution against damage to your parked aircraft by gusty or strong winds. To tie-down your aircraft securely, proceed as follows:

- (1) Set the parking brake and install control wheel lock.
- (2) Tie strong ropes or chains (700 pounds tensile strength) to wing tie-down fittings.
- (3) Caster the nose wheel to the extreme left or right position.
- (4) Tie a strong rope or chain (700 pounds tensile strength) to the tail tie-down fitting. (Do not impose side loads on tie-down fitting.)
- (5) Recommend installation of pitot tube cover.

## WINDOWS AND WINDSHIELD

The plastic windshield and windows should be kept clean and waxed at all times. To prevent scratches and crazing, wash them carefully with plenty of soap and water, using the palm of the hand to feel and dislodge dirt and mud. A soft cloth, chamois or sponge may be used, but only to carry water to the surface. Rinse thoroughly, then dry with a clean, moist chamois. Rubbing the surface of the plastic with a dry cloth builds up an electrostatic charge which attracts dust particles in the air. Wiping with a moist chamois will remove both the dust and this charge.

Remove oil and grease with a cloth moistened with kerosene. Never use gasoline, benzene, acetone, carbon tetrachloride, fire extinguisher fluid, lacquer thinner or glass cleaner. These materials will soften the plastic and may cause it to craze.



After removing dirt and grease, if the surface is not badly scratched, it should be waxed with a good grade of commercial wax. The wax will fill in minor scratches and help prevent further scratching. Apply a thin, even coat of wax and bring it to a high polish by rubbing lightly with a clean, dry, soft flannel cloth. Do not use a power buffer; the heat generated by the buffing pad may soften the plastic.

Do not use a canvas cover on the windshield unless freezing rain or sleet is anticipated. Canvas covers may scratch the plastic surface.

## **PAINTED SURFACES**

The painted exterior surfaces of your new Cessna require an initial curing period which may be as long as 90 days after the finish is applied. During this curing period some precautions should be taken to avoid damaging the finish or interfering with the curing process. The finish should be cleaned only by washing with clean water and mild soap, followed by a rinse water and drying with cloths or a chamois. Do not use polish or wax, which would exclude air from the surface, during this 90-day curing period. Do not rub or buff the finish and avoid flying through rain, hail, or sleet.

Once the finish has cured completely, it may be waxed with a good automotive wax. A heavier coating of wax on the leading edges of the wings, tail, engine nose cap and propeller spinner will help reduce the abrasion encountered in these areas.

## **PROPELLER CARE**

Preflight inspection of propeller blades for nicks, and wiping them occasionally with an oily cloth to clean off grass and bug stains will assure long, trouble-free service. It is vital that small nicks on the propellers, particularly near the tips and on the leading edges, are dressed out as soon as possible since these nicks produce stress concentrations, and if ignored, may result in cracks. Never use an alkaline cleaner on the blades; remove grease and dirt with Stoddard solvent. Do not feather propeller below 700 RPM as this may damage the hub mechanism.

## **INTERIOR CARE**

To remove dust and loose dirt from the upholstery, headliner, and carpet, clean the interior regularly with a vacuum cleaner.

Blot up any spilled liquid promptly, with cleansing tissue or rags. Don't pat the spot; press the blotting material firmly and hold it for sev-

eral seconds. Continue blotting until no more liquid is taken up. Scrape off sticky materials with a dull knife, then spot-clean the area.

Oily spots may be cleaned with household spot removers, used sparingly. Before using any solvent, read the instructions on the container and test it on an obscure place on the fabric to be cleaned. Never saturate the fabric with a volatile solvent; it may damage the padding and backing materials.

Soiled upholstery and carpet may be cleaned with foam-type detergent, used according to the manufacturer's instructions. To minimize wetting the fabric, keep the foam as dry as possible and remove it with a vacuum cleaner.

The plastic trim, instrument panel and control knobs need only be wiped with a damp cloth. Oil and grease on the control wheel and control knobs can be removed with a cloth moistened with kerosene. Volatile solvents, such as mentioned in paragraphs on care of the windshield, must never be used since they soften and craze the plastic.

## **FLYABLE STORAGE**

Flyable storage applies to all aircraft which will not be flown for an indefinite period but which are to be kept ready to fly with the least possible preparation. If the aircraft is to be stored temporarily, or indefinitely, refer to the Service Manual for proper storage procedures.

Aircraft which are not in daily flight should have the propellers rotated, by hand, five revolutions at least once each week. In damp climates and in storage areas where the daily temperature variation can cause condensation, propeller rotation should be accomplished more frequently. Rotating the propeller an odd number of revolutions, redistributes residual oil on the cylinder walls, crankshaft and gear surfaces and repositions the pistons in the cylinders, thus preventing corrosion. Rotate propellers as follows:

- (1) Throttles - IDLE.
- (2) Mixtures - IDLE CUT-OFF.
- (3) Magneto Switches - OFF.
- (4) Propellers - ROTATE CLOCKWISE. Manually rotate propellers five revolutions, standing clear of arc of propeller blades.

Keep fuel tanks full to minimize condensation in the fuel tanks. Maintain battery at full charge to prevent electrolyte from freezing in cold weather. If the aircraft is stored outside, tie-down aircraft in anticipa-

tion of high winds. Secure aircraft as follows:

- (1) Secure rudder with the optional rudder gust lock or with a control surface lock over the fin and rudder. If a lock is not available, caster the nose wheel to the full left or right position.
- (2) Install control column lock in pilot's control column, if available. If column lock is not available, tie the pilot's control wheel full aft with a seat belt.
- (3) Tie ropes or chains to the wing tie-down fittings located on the underside of each wing. Secure the opposite ends of the ropes or chains to ground anchors. Chock the main landing gear tires; do not set the parking brake if a long period of inactivity is anticipated as brake seizing can result.
- (4) Secure a rope (no chains or cables) to the upper nose gear trunion and secure opposite end of rope to a ground anchor. Chock the nose landing gear tire.
- (5) Secure the middle of a rope to the tail tie-down fitting. Pull each end of rope at a 45-degree angle and secure to ground anchors at each side of the tail.
- (6) After 30 days, the aircraft should be flown for 30 minutes or run engines on the ground until oil temperatures reach operating temperatures.

#### NOTE

Excessive ground operation is to be avoided so that maximum cylinder head temperatures are not exceeded.

## INSPECTION SERVICE AND INSPECTION PERIODS

With your aircraft you will receive a Customer Care Program booklet. Coupons attached to the booklet entitle you to an initial inspection and the first 100-hour inspection at no charge. If you take delivery from your Dealer, he will perform the initial inspection before delivery of the aircraft to you. If you pick up the aircraft at the factory, plan to take it to your Dealer reasonably soon after you take delivery of it. This will permit him to check it over and to make any minor adjustments that may appear necessary. Also, plan an inspection by your Dealer at 100 hours or 180 days, whichever comes first. This inspection is also performed

for you by your Dealer at no charge. While these important inspections will be performed for you by any Cessna Dealer, in most cases you will prefer to have the Dealer from whom you purchased the aircraft accomplish this work.

Federal Aviation Regulations require that all aircraft have a periodic (annual) inspection as prescribed by the administrator, and performed by a person designated by the administrator. In addition, 100-hour periodic inspections made by an "appropriately-rated mechanic" are required if the aircraft is flown for hire. The Cessna Aircraft Company recommends the 100-hour periodic inspection for your aircraft. The procedure for this 100-hour inspection has been carefully worked out by the factory and is followed by the Cessna Dealer Organization. The complete familiarity of the Cessna Dealer Organization with Cessna equipment and with factory-approved procedures provides the highest type of service possible at lower cost.

## **OWNER FOLLOW-UP SYSTEM**

Your Cessna Dealer has an Owner Follow-up System to notify you when he receives information that applies to your Cessna. In addition, if you wish, you may choose to receive similar notification, in the form of Service Letters, directly from the Cessna Customer Services Department. A subscription form is supplied in your Customer Care Program booklet for your use should you choose to request this service. Your Cessna Dealer will be glad to supply you with details concerning these follow-up programs, and stands ready, through his Service Department, to supply you with fast, efficient, low cost service.

## **PUBLICATIONS**

Included in your aircraft file are various manuals which describe the operation of the equipment in your aircraft. These manuals, plus many other supplies that are applicable to your aircraft, are available from your Cessna Dealer, and for your convenience, are listed below.

- **OWNER'S MANUALS FOR YOUR AIRCRAFT**
  - ELECTRONICS - 300, 400 and 800 SERIES**
  - AUTOPILOT - NAV-O-MATIC 400 and 400A**
  - INTEGRATED FLIGHT CONTROL SYSTEM-  
300, 400 and 800**

- SERVICE MANUALS AND PARTS CATALOGS FOR YOUR AIRCRAFT
  - ENGINE AND ACCESSORIES
  - ELECTRONICS - 300, 400 and 800 SERIES
  - AUTOPILOT - NAV-O-MATIC 400 and 400A
  - INTEGRATED FLIGHT CONTROL SYSTEM - 300, 400 and 800
  - HEATER AND COMPONENTS
- COMPUTER
- SALES AND SERVICE DEALER DIRECTORY
- DO'S AND DON'TS ENGINE BOOKLET

Your Cessna Dealer has a current catalog of all Customer Services Supplies that are available, many of which he keeps on hand. Supplies which are not in stock, he will be happy to order for you.

## AIRCRAFT FILE

There are miscellaneous data, information and licenses that are a part of the aircraft file. The following is a checklist for that file. In addition, a periodic check should be made of the latest Federal Aviation Regulations to insure that all data requirements are met.

- A. To be displayed in the aircraft at all times:
  - (1) Aircraft Airworthiness Certificate (FAA Form 8100-2).
  - (2) Aircraft Registration Certificate (AC Form 8050-3).
  - (3) Aircraft Radio Station License (Form FCC-556, if transmitter installed).
- B. To be carried in the aircraft at all times:
  - (1) Weight and Balance, and associated papers (latest copy of the Repair and Alteration Form, Form FAA-337, if applicable).
  - (2) Aircraft Equipment List
  - (3) Pilot's Checklist.
- C. To be made available upon request:
  - (1) Aircraft Log Book.
  - (2) Engine Log Books.

## NOTE

Cessna recommends that these items plus the Owner's Manual, power computer, Customer Care Program booklet and Customer Care Card, be carried in the aircraft at all times.

Most of the items listed are required by the United States Federal Aviation Regulations. Since the regulations of other nations may require other documents and data, owners of exported aircraft should check with their own aviation officials to determine their individual requirements.

## LUBRICATION AND SERVICING PROCEDURES

Specific servicing information is provided here for items requiring daily attention. A Servicing Intervals Checklist is included to inform the pilot when to have other items checked or serviced.

### DAILY

**FUEL TANK FILLERS** -- Service after each flight. Keep full to retard condensation in tanks. Refer to Servicing Requirements table on inside back cover for fuel specification, grade and quantity.

**FUEL TANK DRAINS** -- Drain before first flight each day and after each refueling.

**FUEL STRAINER DRAINS** -- Drain about two (2) ounces of fuel from each fuel strainer before first flight each day and after refueling.

**FUEL LINE CROSSOVER DRAINS** -- Drain about two (2) ounces of fuel from each valve before first flight each day.

**OIL FILLERS** -- When preflight check shows low oil level, service with aviation grade engine oil; SAE 50 above 40° F and SAE 10W30 or SAE 30 below 40° F. (Multi-viscosity oil with a range of 10W30 is recommended for improved starting in cold weather.) Detergent or dispersant oil conforming to Continental Motors Spec. MHS-24A must be used. Your Cessna Dealer can supply approved brands of oil.

## NOTE

To promote faster ring seating and improved oil control, your Cessna was delivered from the factory with straight mineral oil (non-detergent). This "break-in" oil should be used only for the first 20 or 30 hours of operation, at which time it must be replaced with detergent oil.

**OIL DIPSTICKS** -- Check oil level before each flight. Do not operate on less than 9 quarts. To minimize loss of oil through breather, fill to 10 quart level for normal flights of less than 3 hours. For extended flight, fill to capacity which is 13 quarts for each engine sump including oil filter.

**OXYGEN CYLINDER** -- Check oxygen pressure gage for anticipated requirements before each flight. Refill whenever pressure drops below 300 PSI. Refer to Servicing Requirements table on inside back cover for oxygen specification.

**TIRES** -- Check tires for proper inflation. Refer to Servicing Requirements table on inside back cover for proper tire pressure.

## SERVICING INTERVALS CHECKLIST

### EACH 50 HOURS

**BATTERIES** -- Check and service. Check more often (at least every 30 days) if operating in hot weather.

**INDUCTION AIR FILTER** -- Service every 50 hours, more often under dusty conditions.

**ENGINE OIL AND OIL FILTER** -- Change engine oil and replace filter element. If optional oil filter is not installed, change oil and clean screen every 25 hours. Change engine oil every fifty hours, or, every four months even though less than 50 hours have been accumulated. Reduce periods for prolonged operation in dusty areas, cold climates, or when short flights and long idle periods result in sludging conditions. Always change oil whenever oil on dipstick appears dirty.

## **EACH 100 HOURS**

SHIMMY DAMPENER -- Check and fill as required.

BRAKE MASTER CYLINDERS -- Check fluid level in reservoirs and fill as required through plugs on cylinder heads. Fill with hydraulic fluid (Red).

SUCTION RELIEF VALVE -- Remove filters and clean.

HEATER FUEL FILTER -- Remove and clean with unleaded gasoline.

OIL SEPARATORS -- Remove and clean.

## **EACH 500 HOURS**

SHOCK STRUTS -- Check and fill as required.

VACUUM SYSTEM FILTER -- Replace.

WHEEL BEARINGS -- Lubricate. Lubricate at first 100 hours and each 500 hours thereafter. If more than the normal number of take-offs and landings are made, extensive taxiing is required, or the aircraft is operated in dusty areas or under seacoast conditions, it is recommended that cleaning and lubrication of wheel bearings be accomplished at each 100-hour inspection.

### **NOTE**

    Servicing intervals in the above check list are recommended by The Cessna Aircraft Company. Depending upon the type of operation, Government regulations may require servicing and inspection of additional items. For these requirements Owner's should check with aviation officials in the country where the aircraft is being operated.



The operational data on the following pages are presented for two purposes; first, so that you may know what to expect from your aircraft under various conditions and second, to enable you to plan your flights in detail and with reasonable accuracy.

A power setting selected from the range charts usually will be more efficient than a random setting, since it will permit accurate fuel flow settings and your fuel consumption can be estimated closely. You will find that using the charts and your power computer will pay dividends in over-all efficiency.

The data in the charts has been compiled from actual flight tests with the aircraft and engines in good conditions, and using average piloting techniques. Note also that the range charts make no allowances for wind, navigational errors, warm-up, takeoff, climb, etc. You must estimate these variables for yourself and make allowances accordingly.

<b>AIRSPEED NOMENCLATURE SUMMARY</b>			
<b>GROSS WEIGHT 5300 POUNDS</b>			
<b>MULTI-ENGINE</b>	<b>MPH-IAS</b>	<b>SINGLE ENGINE</b>	<b>MPH-IAS</b>
Takeoff & Climb to 50 Ft. (0° Flaps)	105	Minimum Control Speed	86
Best Angle of Climb Speed	93	Takeoff & Climb to 50 Ft. (0° Flaps)	105
Best Rate-of-Climb Speed	123	Best Angle of Climb Speed	108
Landing Approach Speed (35° Flaps)	103	Best Rate-of-Climb Speed	116
Maneuvering Speed	170	Landing Approach Speed (35° Flaps)	108
Structural Cruise Speed	210	When Landing is Assured	103
Never Exceed Speed (Red Line)	257		

<b>AIRSPEED CORRECTION TABLE</b>					
<b>FLAPS 0°</b>		<b>FLAPS 15°*</b>		<b>FLAPS 35°**</b>	
<b>IAS, MPH</b>	<b>CAS, MPH</b>	<b>IAS, MPH</b>	<b>CAS, MPH</b>	<b>IAS, MPH</b>	<b>CAS, MPH</b>
80	80	80	82	70	72
100	101	90	92	80	82
120	121	100	102	90	91
140	142	110	111	100	101
160	162	120	122	110	110
180	183	130	132	120	120
200	203	140	142	130	130
220	224	150	152	140	140
240	244	160	162	150	149
		170	172	160	159
		180	182		

\* Maximum Flap Speed 180 MPH-CAS (15°)      \*\* Maximum Flap Speed 160 MPH-CAS (35°)

Figure 6-1

<b>STALL SPEED CHART</b>								
<b>MPH (IAS IS APPROXIMATE)</b>								
<b>5300 POUNDS GROSS WEIGHT</b>								
<b>CONFIGURATION</b>	<b>ANGLE OF BANK</b>							
	<b>0°</b>		<b>20°</b>		<b>40°</b>		<b>60°</b>	
	<b>IAS</b>	<b>CAS</b>	<b>IAS</b>	<b>CAS</b>	<b>IAS</b>	<b>CAS</b>	<b>IAS</b>	<b>CAS</b>
<b>Gear and Flaps Up</b>	86	86	89	89	98	98	121	122
<b>Gear Down and Flaps 15°</b>	81	82.5	83.5	85	92.5	94	115.5	117
<b>Gear Down and Flaps 35°</b>	72	73.5	74.5	76	83	84	103.5	104

Figure 6-2

# NORMAL TAKEOFF DISTANCE

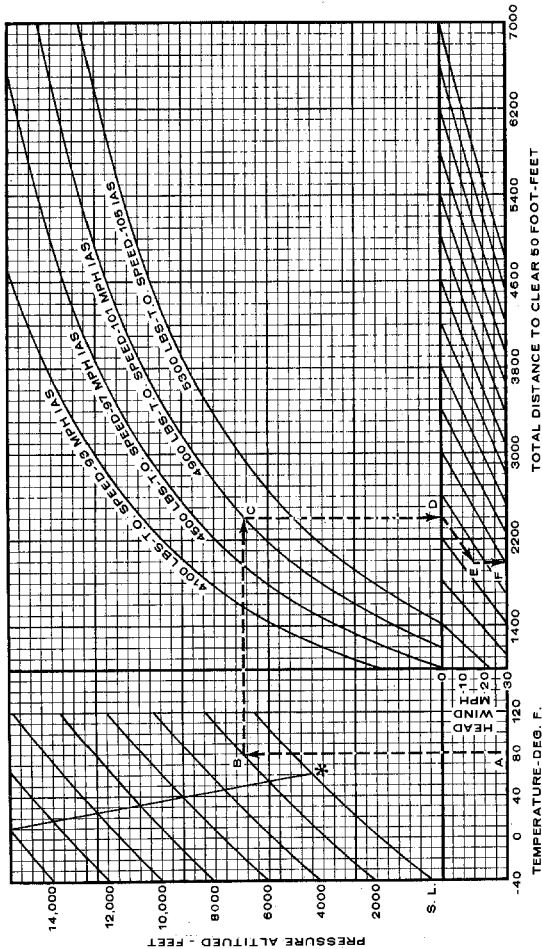

\* STANDARD TEMPERATURE

**CONDITIONS**

1. Level Hard Surface Runway.
  2. Wing Flaps - UP.
  3. Full Throttle and 2625 RPM Before Releasing Brakes.
  4. Mixture at Recommended Fuel Flow.
  5. Maintain Speed to 50 Ft.
- NOTE: Ground Run is 87% of Total Distance.  
Increase Total Distance by 3.5% for Operation on Firm Dry Sod Runways.

**EXAMPLE**

- A. Temperature - 80° F.
- B. Pressure Altitude - 2000 Ft.
- C. Gross Weight - 4900 Lbs.
- D. Total Distance to Clear 50 Ft.
- E. Headwind - 15 MPH
- F. Total Distance to Clear 50 Ft. (15 MPH Headwind) - 1970 Ft.

Figure 6-3

# ACCELERATE STOP DISTANCE

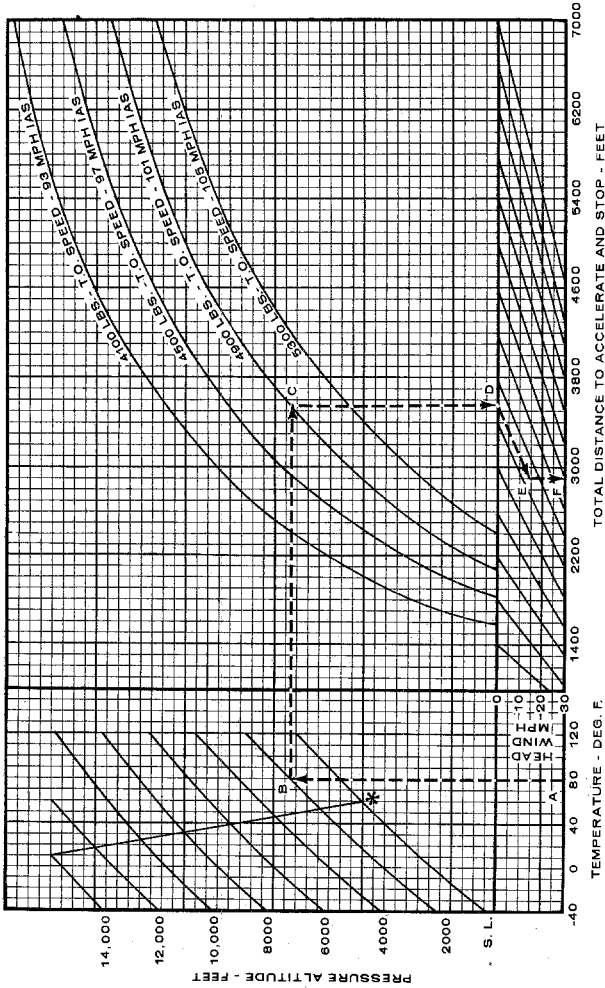

## CONDITIONS

1. Level Hard Surface Runway.
2. Wing Flaps - UP.
3. Full Throttle and 2825 RPM Before Releasing Brakes.
4. Mixture at Recommended Fuel Flow.
5. Engine Failure at Takeoff Speed.
6. Heavy Braking After Engine Failure.

\* STANDARD TEMPERATURE

## EXAMPLE

- A. Temperature - 80° F.
- B. Pressure Altitude - 2000 Ft.
- C. Gross Weight - 4900 Lbs.
- D. Distance to Stop (No Wind) - 3560 Ft.
- E. Headwind - 15 MPH.
- F. Distance to Stop (15 MPH Headwind) - 2900 Ft.

Figure 6-4

# SINGLE ENGINE TAKEOFF DISTANCE

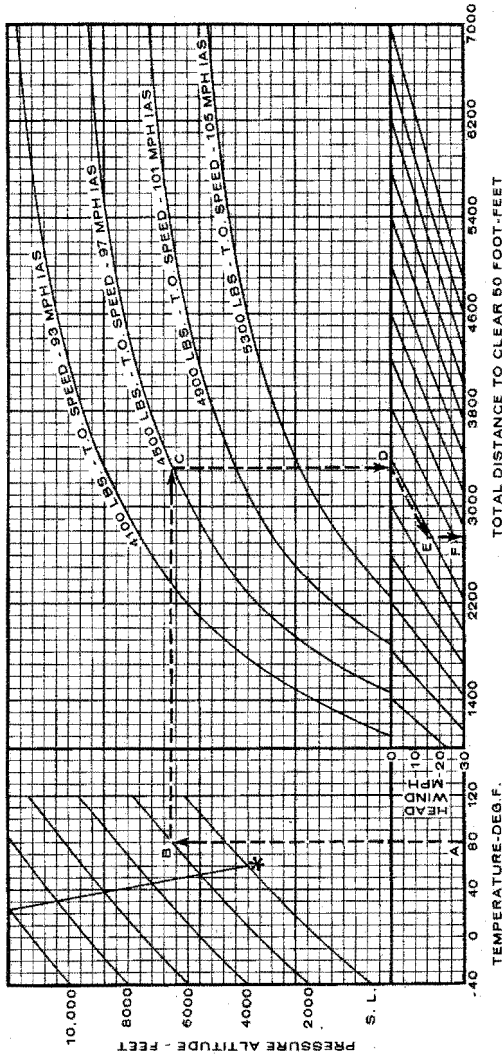

TOTAL DISTANCE TO CLEAR 50 FOOT-HEIGHT

\* STANDARD TEMPERATURE

CONDITIONS

1. Level Hard Surface Runway
  2. Wing Flaps Up
  3. Full Throttle and 2625 RPM Before Releasing Brakes
  4. Mixture at Recommended Fuel Flow
  5. Engine Failure at Takeoff Speed During Climb
  6. Propeller Feathered and Gear Retracted
  7. Maintain Speed to 50 Feet
- EXAMPLE**
- A. Temperature - 80° F
  - B. Pressure Altitude - 2000 Ft.
  - C. Gross Weight - 4500 Lbs.
  - D. Total Distance to Clear 50 Ft. (No Wind) - 3320 Ft.
  - E. Headwind - 15 MPH
  - F. Total Distance to Clear 50 Ft. (15 MPH Headwind) - 2750 Ft.

Figure 6-5

# MULTI-ENGINE CLIMB DATA AT 5300 POUNDS

NOTE: DECREASE RATE OF CLIMB 20 FT./MIN FOR EACH 10° F ABOVE STANDARD TEMPERATURE FOR A PARTICULAR ALTITUDE.

## MAXIMUM CLIMB

SEA LEVEL 59° F		5000 FT. 41° F			10,000 FT. 23° F			15,000 FT. 5° F			20,000 FT. -12° F			
Best Climb MPH	Rate of Climb Ft/Min	Libs Fuel Used	Best Climb IAS MPH	Rate of Climb Ft/Min	From S. L. Fuel Used	Best Climb IAS MPH	Rate of Climb Ft/Min	From S. L. Fuel Used	Best Climb IAS MPH	Rate of Climb Ft/Min	From S. L. Fuel Used	Best Climb IAS MPH	Rate of Climb Ft/Min	From S. L. Fuel Used
123	1495	24	122	1136	39	121	782	56	120	427	80	119	96	136

NOTE: FULL THROTTLE, 2625 RPM, MIXTURE AT RECOMMENDED FUEL FLOW, FLAPS AND GEAR UP. FUEL USED INCLUDES WARM-UP AND TAKEOFF ALLOWANCE.

## CRUISE CLIMB

NOTE: 2450 RPM, 24 IN. MP TO 5000 FT. FULL THROTTLE AFTERWARDS.

		5000 FT. 41° F			10,000 FT. 23° F			15,000 FT. 5° F		
		FROM SEA LEVEL			FROM SEA LEVEL			FROM SEA LEVEL		
RPM	M. P.	Dist. Miles	Time Min.	Fuel Used Lbs.	Dist. Miles	Time Min.	Fuel Used Lbs.	Dist. Miles	Time Min.	Fuel Used Lbs.
	2450	24	11.9	5.0	40	28.6	11.5	59	66.9	25.2

NOTE: WARM-UP AND TAKEOFF ALLOWANCE 24 POUNDS FUEL AT SEA LEVEL. MIXTURE AT RECOMMENDED FUEL FLOW, FLAPS AND GEAR UP.

Figure 6-6

## MAXIMUM PERFORMANCE TAKEOFF 15° FLAPS

Gross Weight Pounds	IAS at Takeoff MPH	IAS at Obstacle MPH	Head Wind MPH	DENSITY ALTITUDE							
				SEA LEVEL 59°F		2500 FT 50°F		5000 FT 41°F		7500 FT 32°F	
				Ground Run	Total Distance over 50 Ft Obstacle	Ground Run	Total Distance over 50 Ft Obstacle	Ground Run	Total Distance over 50 Ft Obstacle	Ground Run	Total Distance over 50 Ft Obstacle
5300	90	90	0 15 30	1519 1178 874	1795 1413 1059	1911 1496 1125	2234 1773 1357	2453 1939 1477	2837 2271 1757	3234 2580 1990	3702 2987 2336

Figure 6-7

## SINGLE ENGINE CLIMB DATA

Gross Weight Pounds	SEA LEVEL 59°F		2500 FT 50°F		5000 FT 41°F		7500 FT 32°F		10,000 FT 23°F	
	Best Climb IAS MPH	Rate of Climb Ft/Min	Best Climb IAS MPH	Rate of Climb Ft/Min	Best Climb IAS MPH	Rate of Climb Ft/Min	Best Climb IAS MPH	Rate of Climb Ft/Min	Best Climb IAS MPH	Rate of Climb Ft/Min
5300	116	327	115	224	113	119	112	15	110	-89
4900	114	400	113	298	111	195	109	92	108	-10
4500	110	463	109	360	107	265	106	151	105	47

NOTE: Flaps and gear up, inoperative propeller-feathered, wing banked 5° toward operating engine, full throttle, 2825 RPM and mixture at recommended leaning schedule. Decrease rate of climb 10 FT/MIN for each 10°F above standard temperature for particular altitude.

Figure 6-8

## SINGLE ENGINE SERVICE CEILING BEST CLIMB SPEED APPROXIMATELY 116 MPH IAS

Gross Weight Pounds	OUTSIDE AIR TEMPERATURE °F						
	-10	0	10	20	30	40	50
	ALTITUDE- FEET						
5300	7550	7360	7180	6970	6750	6560	6400
4900	9300	9100	8900	8650	8400	8170	7900
4500	10,600	10,400	10,200	9900	9630	9400	9100

NOTE: Table provides performance information to aid in route selection when operating under FAR 135.145 and FAR 91.119 requirements.

Increase indicated service ceilings 100 feet for each 0.10 inch Hg. altimeter setting greater than 29.92

Decrease indicated service ceilings 100 feet for each 0.10 inch Hg. altimeter setting less than 29.92.

The service ceilings are the highest attainable while maintaining a minimum rate-of-climb of 50 ft/min.

Figure 6-9

**CRUISE PERFORMANCE WITH RECOMMENDED LEAN MIXTURE AT 2500 FT**

RPM	MP	%BHP	TAS	Total Lbs./Hr.	Endurance 600 Lbs.	Range 600 Lbs.	Endurance 978 Lbs.	Range 978 Lbs.	Endurance 1218 Lbs.	Range 1218 Lbs.
2450	24	74	208	168	3.57	743	5.82	1211	7.25	1508
	23	70	204	158	3.80	773	6.19	1260	7.71	1570
	22	66	198	147	4.08	810	6.85	1320	8.29	1644
	21	62	193	139	4.32	830	7.04	1358	8.76	1691
2300	24	68	201	153	3.92	789	6.39	1287	7.96	1603
	23	64	196	143	4.20	821	6.84	1338	8.52	1667
	22	60	190	135	4.44	846	7.24	1379	9.02	1718
	21	56	184	127	4.72	871	7.70	1421	9.59	1769
2200	23	58	187	131	4.58	859	7.47	1400	9.30	1743
	22	55	182	124	4.84	881	7.89	1436	9.82	1789
	21	50	174	116	4.17	899	8.43	1465	10.50	1825
	20	47	168	110	5.45	917	8.89	1495	11.07	1861
2100	22	49	172	113	5.31	914	8.65	1490	10.78	1856
	21	46	166	107	5.61	931	9.14	1517	11.38	1890
	20	43	158	101	5.94	940	9.68	1532	12.06	1908
	19	40	151	97	6.19	934	10.08	1522	12.56	1896
	18	37	139	90	6.67	923	10.87	1505	13.53	1874

CRUISE PERFORMANCE IS BASED ON STANDARD CONDITIONS, ZERO WIND, (50°F) RECOMMENDED LEAN MIXTURE, 600, 978 AND 1218 LBS. OF FUEL (NO RESERVE), AND 5300 POUNDS GROSS WEIGHT.

NOTE: See Range Profile, Figure 6-11, for range including climb.

**CRUISE PERFORMANCE WITH RECOMMENDED LEAN MIXTURE AT 5000 FT**

RPM	MP	%BHP	TAS	Total Lbs./Hr.	Endurance 600 Lbs.	Range 600 Lbs.	Endurance 978 Lbs.	Range 978 Lbs.	Endurance 1218 Lbs.	Range 1218 Lbs.
2450	24	77	217	174	3.45	747	5.62	1217	7.00	1516
	23	73	212	164	3.66	774	5.96	1262	7.43	1572
	22	68	205	154	3.90	800	6.35	1303	7.91	1623
	21	64	200	145	4.14	827	6.74	1348	8.40	1678
2300	24	70	208	157	3.82	794	6.23	1295	7.76	1613
	23	66	202	148	4.05	819	6.61	1335	8.23	1662
	22	62	197	139	4.32	851	7.04	1387	8.76	1727
	21	58	191	131	4.60	876	7.47	1427	9.30	1778
2200	23	61	196	136	4.41	862	7.19	1406	8.96	1751
	22	57	189	128	4.69	886	7.64	1445	9.52	1799
	21	53	183	121	4.96	906	8.08	1478	10.07	1840
	20	50	177	115	5.22	923	8.50	1504	10.59	1874
2100	22	51	179	118	5.08	909	8.29	1482	10.32	1846
	21	48	173	111	5.41	935	8.81	1523	10.97	1897
	20	45	166	106	5.66	942	9.23	1535	11.49	1912
	19	42	157	99	6.06	951	9.88	1551	12.30	1932
	18	39	147	94	6.36	935	10.40	1524	12.96	1898

CRUISE PERFORMANCE IS BASED ON STANDARD CONDITIONS, ZERO WIND, (41°F) RECOMMENDED LEAN MIXTURE, 600, 978 AND 1218 LBS. OF FUEL (NO RESERVE), AND 5300 POUNDS GROSS WEIGHT.

NOTE: See Range Profile, Figure 6-11, for range including climb.

Figure 6-10 (Sheet 1 of 3)



**CRUISE PERFORMANCE WITH RECOMMENDED LEAN MIXTURE AT 7500 FT**

RPM	MP	%BHP	TAS	Total Lbs./Hr	Endurance 600 Lbs.	Range 600 Lbs.	Endurance 978 Lbs.	Range 978 Lbs.	Endurance 1218 Lbs.	Range 1218 Lbs.
2450	22	71	214	159	3.77	807	6.15	1315	7.66	1638
	21	67	208	150	4.00	833	6.52	1357	8.12	1691
	20	63	203	141	4.26	862	6.94	1405	8.64	1750
	19	58	195	132	4.55	888	7.41	1451	9.23	1807
2300	22	64	204	144	4.17	851	6.79	1388	8.46	1728
	21	60	198	136	4.41	874	7.19	1425	8.96	1774
	20	56	191	127	4.72	904	7.70	1474	9.59	1836
	19	53	186	121	4.96	921	8.08	1502	10.07	1870
2200	22	58	195	132	4.55	885	7.41	1443	9.23	1797
	21	55	190	126	4.76	903	7.76	1472	9.67	1834
	20	52	184	119	5.04	928	8.22	1513	10.24	1884
	19	48	176	112	5.36	941	8.73	1534	10.88	1911
2100	21	50	180	115	5.22	940	8.50	1532	10.59	1909
	20	47	173	110	5.45	943	8.89	1537	11.07	1914
	19	44	166	101	5.94	984	9.68	1604	12.06	1997
	18	40	152	97	6.19	939	10.08	1535	12.56	1911

CRUISE PERFORMANCE IS BASED ON STANDARD CONDITIONS, ZERO WIND, (32°F) RECOMMENDED LEAN MIXTURE, 600, 978 AND 1218 LBS. OF FUEL (NO RESERVE) AND 5300 POUNDS GROSS WEIGHT.

NOTE: See Range Profile, Figure 6-11, for range including climb.

**CRUISE PERFORMANCE WITH RECOMMENDED LEAN MIXTURE AT 10,000 FT**

RPM	MP	% BHP	TAS	Total Lbs./Hr	Endurance 600 Lbs.	Range 600 Lbs.	Endurance 978 Lbs.	Range 978 Lbs	Endurance 1218 Lbs.	Range 1218 Lbs.
2450	20	65	210	147	4.08	856	6.65	1395	8.29	1738
	19	61	204	137	4.38	892	7.14	1454	8.89	1811
	18	57	197	129	4.65	915	7.58	1491	9.44	1857
	17	53	189	121	4.96	937	8.08	1528	10.07	1904
2300	20	59	200	133	4.51	903	7.35	1472	9.16	1833
	19	55	193	125	4.80	927	7.82	1512	9.74	1883
	18	51	185	117	5.13	949	8.36	1546	10.41	1926
	17	48	178	111	5.41	961	8.81	1587	10.97	1951
2200	20	54	191	123	4.88	934	7.95	1522	9.90	1895
	19	50	183	116	5.17	945	8.43	1540	10.50	1918
	18	47	175	109	5.50	964	8.97	1571	11.17	1957
	17	44	159	104	5.77	920	9.40	1499	11.71	1867
2100	20	49	180	113	5.31	958	8.65	1561	10.78	1944
	19	46	172	107	5.61	963	9.14	1569	11.38	1954
	18	43	162	102	5.88	955	9.59	1556	11.94	1938
	17	40	140	96	6.25	873	10.19	1422	12.69	1771

CRUISE PERFORMANCE IS BASED ON STANDARD CONDITIONS, ZERO WIND, (23°F) RECOMMENDED LEAN MIXTURE, 600, 978 AND 1218 LBS. OF FUEL (NO RESERVE), AND 5300 POUNDS GROSS WEIGHT.

NOTE: See Range Profile, Figure 6-11, for range including climb.

Figure 6-10 (Sheet 2 of 3)

**CRUISE PERFORMANCE WITH RECOMMENDED LEAN MIXTURE AT 15,000 FT**

RPM	MP	%BHP	TAS	Total Lbs./Hr	Endurance 600 Lbs.	Range 600 Lbs.	Endurance 978 Lbs.	Range 978 Lbs.	Endurance 1218 Lbs.	Range 1218 Lbs.
2450	16	53	195	121	4.96	968	8.08	1578	10.07	1965
	15	48	180	112	5.36	962	8.73	1569	10.88	1954
	14	44	161	104	5.77	931	9.40	1518	11.71	1890
2300	16	48	180	112	5.36	962	8.73	1569	10.88	1954
	15	44	161	104	5.77	931	9.40	1518	11.71	1890
2200	16	44	161	104	5.77	931	9.40	1518	11.71	1890

CRUISE PERFORMANCE IS BASED ON STANDARD CONDITIONS, ZERO WIND, 5.5°F) RECOMMENDED LEAN MIXTURE, 600, 978 AND 1218 LBS. OF FUEL (NO RESERVE), AND 5300 POUNDS GROSS WEIGHT.

NOTE: See Range Profile, Figure 6-11, for range including climb.

Figure 6-10 (Sheet 3 of 3)

# RANGE PROFILE

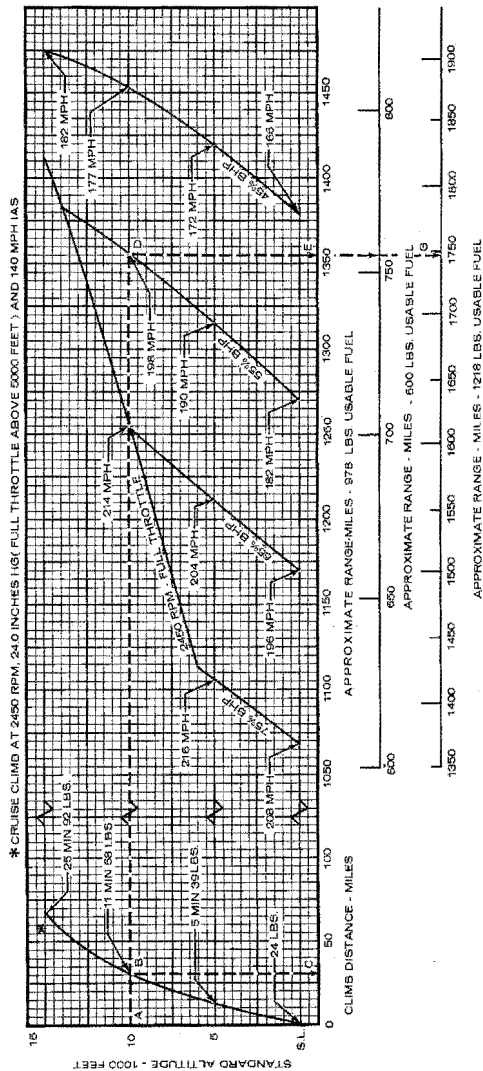

## NOTES

1. Maximum Range is not Changed Appreciably With Variations in Climb Power, Settling and Climb Speed.
2. Climb Fuel Includes Allowance for Start, Taxi and Takeoff.

## CONDITIONS

1. Starting Weight - 5300 Lbs.
2. Cruise Climb to Desired Power - Settling and Climb Speed.
3. Cruise Fuel Flow - Recommended Lean Mixture
4. Zero Wind
5. 45 Min. Reserve Fuel (80 Lbs.) at 45% BRP

## EXAMPLE

- A. Cruising Altitude - 10,000 Ft.
- B. Time and Fuel Used to Climb From Sea Level to 10,000 Ft. - 11 Min. and 58 Lbs.
- C. Climb Distance - 30 Mi.
- D. Cruise Power and Speed - 55% BRP and 198 MPH TAS
- E. Range - 1353 Mi.
- F. (978 Lbs. Usable Fuel - Optional). Range - 765 Mi.
- G. (600 Lbs. Usable Fuel - Standard). Range - 1747 Mi.
- C. (1218 Lbs. Usable Fuel - Optional)

Figure 6-11

## LANDING PERFORMANCE

Gross Weight Pounds	IAS at Obstacle MPH	SEA LEVEL 59°F		2500 FT. 50°F		5000 FT. 41°F		7500 FT. 32°F	
		Ground Run	Total Distance Over 50 Foot Obstacle	Ground Run	Total Distance Over 50 Foot Obstacle	Ground Run	Total Distance Over 50 Foot Obstacle	Ground Run	Total Distance Over 50 Foot Obstacle
5300	103	582	1697	626	1741	675	1790	729	1844
4900	99	490	1605	527	1642	568	1683	613	1728
4500	95	406	1521	437	1552	471	1586	509	1624
4100	90	331	1446	356	1471	384	1499	414	1529

NOTE: WING FLAPS 35°, POWER OFF, HARD SURFACE RUNWAY, ZERO WIND MAXIMUM BRAKING EFFORT, REDUCE LANDING DISTANCE 10% FOR EACH 10 MPH HEADWIND.

NOTE: INCREASE DISTANCE BY 25% OF GROUND RUN FOR OPERATION ON FIRM SOD RUNWAYS.

Figure 6-12

---

This section contains a description, operating procedures, and performance data (when applicable) for some of the optional equipment which may be installed in your aircraft. Contact your Cessna Dealer for a complete list of available optional equipment.

## AUXILIARY FUEL SYSTEM

The auxiliary tanks are available in either of two sizes; 20 U. S. gal. usable each wing or 31.5 U. S. gal. usable each wing. The auxiliary tanks are installed in each wing just outboard of each engine nacelle and feed directly to the fuel selector valves. Fuel vapor and excess fuel from the engines are returned to the main fuel tanks. The auxiliary tank is vented into the main tank. The main tank is in turn vented to the atmosphere.

When the selector valve handles are in the AUXILIARY position, the left auxiliary tank feeds the left engine and the right auxiliary tank feeds the right engine. The fuel quantity indicator continuously indicates fuel remaining in the tanks selected. When the fuel selector handles are in the AUXILIARY position, AUX TANK indicator lights will illuminate and the fuel quantity gage will indicate the fuel in the auxiliary tanks (pounds in white and gallons in blue). When the fuel selector handles are in the MAIN position, the fuel quantity gage will indicate the fuel in the main tanks. A three-position switch, spring-loaded to center, allows checking fuel quantity in the tanks not selected. The switch, adjacent to the auxiliary tank indicator lights, is labeled MAIN and AUX. By positioning the switch to the appropriate tank position, the fuel quantity in that tank will be indicated on the fuel quantity gage.

If the auxiliary tanks are to be used, select fuel from the main tanks for 60 minutes with 20 gal. tank and 90 minutes with 31.5 gal. tank prior to switching to auxiliary tanks. This is necessary to provide space in the main tanks for vapor and fuel returned from the engine-driven fuel pumps. If sufficient space is not available in the main tanks for this diverted fuel, the tanks can overflow through the vent line. Since part of the fuel from the auxiliary tanks is diverted back to the main tanks instead of being consumed by the engines, the auxiliary tanks will run dry sooner than may be

anticipated. However, the main endurance will be increased by the returned fuel. The total usable fuel supply is available during cruising flight only. An engine failure or engine driven pump failure results in the auxiliary fuel on the side of the failure being unusable. Operation on the auxiliary fuel tanks near the ground (below 1000 feet AGL) is not recommended.

## OPTIONAL WING LOCKER FUEL SYSTEM

Optional wing locker fuel tanks (20 gal. usable each wing) are installed in the forward portion of the nacelle wing lockers. There are no separate fuel selector controls for the wing locker fuel tanks. The wing locker fuel is pumped directly into the main tanks with a fuel transfer pump. Indicator lights mounted on the instrument panel are illuminated by pressure switches to indicate fuel has been transferred. The wing locker fuel should not be transferred until there is 180 lbs. or less in the main fuel tanks to prevent overflow of the main tank fuel. Fuel should be crossed as required to maintain fuel balance after wing locker fuel has been transferred.

### NOTE

Wing locker transfer pump switches provided on the instrument panel, energize the wing locker fuel transfer pumps for transferring fuel. These switches should be turned ON only to transfer fuel and turned OFF when the indicator lights come ON indicating fuel has been transferred.

## OXYGEN SYSTEM

The oxygen system is designed to provide adequate oxygen flow rates for altitudes up to 30,000 feet. The pilot and passengers shall always use the blue hose assemblies. The system consists of a 76.6 or 48.3 cubic foot oxygen bottle, an altitude compensated regulator, oxygen bottle pressure indicator, a mechanically actuated on-off valve and the necessary outlets and plumbing. See Figure 7-1 for oxygen consumption rates at various altitudes.

# OXYGEN DURATION CHART

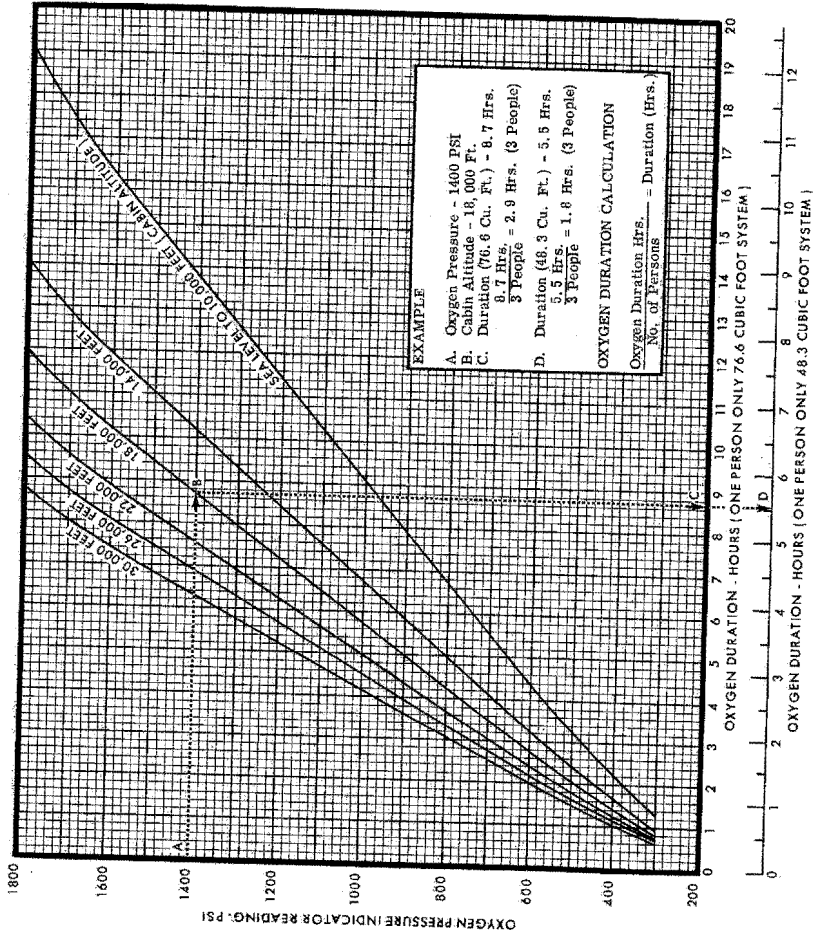

Figure 7-1

## OXYGEN SYSTEM OPERATION

The oxygen system is activated by pulling the oxygen knob to the ON position, allowing oxygen to flow from the regulator to all cabin outlets. A normally closed valve in each oxygen outlet is opened by inserting the connector of the mask and hose assembly. After flights using oxygen, the pilot should ensure that the oxygen system has been inactivated by unplugging all masks and pushing the oxygen knob completely to the OFF position.

### NOTE

If the oxygen knob is left in an intermediate position between ON and OFF, it may allow low pressure oxygen to bleed through the regulator into the nose compartment of the aircraft.

### Before Flight:

- (1) Oxygen Knob - PULL ON.
- (2) Oxygen Pressure Gauge - Check for sufficient pressure for anticipated flight requirements. (See figure 7-1.)
- (3) Check that oxygen masks and hose assemblies are available.

### During Flight:

### WARNING

Permit no smoking when using oxygen. Oil, grease, soap, lipstick, lip balm, and other fatty materials constitute a serious fire hazard when in contact with oxygen. Be sure hands and clothing are oil-free before handling oxygen equipment.

- (1) Mask - Connect mask and hose assembly and put mask on.
- (2) Hose Coupling - Plug into overhead console.



- (3) Oxygen Flow Indicator - Check Flow. (Indicator toward mask indicates proper flow.)
- (4) Disconnect hose coupling from console when not in use.

AMBIENT TEMPERATURE ° F	FILLING PRESSURE PSIG		AMBIENT TEMPERATURE ° F	FILLING PRESSURE PSIG
0	1600		70	1925
10	1650		80	1950
20	1675		90	2000
30	1725		100	2050
40	1775		110	2100
50	1825		120	2150
60	1875		130	2200

Example - If ambient temperature is 70° F, fill oxygen cylinder to approximately 1925 psig - as close to this pressure as the gage can be read. Upon cooling, the cylinder should have approximately 1800 psi pressure.

Figure 7-2

## OXYGEN SYSTEM SERVICING

The oxygen cylinder, when fully charged, contains 76.6 or 48.3 cubic feet of oxygen, under a pressure of 1800 psi at 70° F. Filling pressures will vary, however, due to the ambient temperature in the filling area, and because of the temperature rise resulting from compression of the oxygen. Because of this, merely filling to 1800 psi will not result in a properly filled cylinder. Fill to the pressures indicated in Figure 7-2 for the ambient temperature.

### NOTE

Oil, grease, or other lubricants in contact with oxygen create a serious fire hazard, and such contact must be avoided when handling oxygen equipment.

The cylinder is serviced through an external filler valve located just above the aft end of the nosewheel doors. The Servicing Requirements table, located on the inside back cover of the manual, lists the correct type of oxygen for refilling the cylinder.

The face masks used with the oxygen system are the partial-rebreathing type. The pilot's mask is a permanent type mask, while the remainder are the semi-permanent type. They may be cleaned with alcohol or used as disposable masks. Additional masks and hose assemblies are available from your Cessna Dealer.

## **COLD WEATHER EQUIPMENT**

### **WINTERIZATION KIT**

A winterization kit consisting of engine cooling air inlet restrictor baffles is available for use during continuous operation in very low temperature conditions. These baffles may be installed as an assist in maintaining engine cylinder head temperatures in recommended temperature range. The winterization kit must be removed at temperatures of 20°F or above.

## **PROPELLER DEICE SYSTEM**

The propeller deice system consists of electrically heated boots on the propeller blades. Each boot consists of two heating elements "Outboard" and "Inboard," which receive their electrical power through a deice timer. To reduce power drain and maintain propeller balance, the timer directs current to the propeller boots in cycles between boot elements and between propellers.

### **NORMAL OPERATION**

To operate the propeller deice system proceed as follows:

- (1) Battery Switch - ON.
- (2) Propeller Deice Switch/Circuit Breaker - ON (up position).
- (3) Ammeter - CHECK.

### NOTE

Periodic fluctuation (2 bladed 8 to 12 Amp. and 3 bladed 12 to 18 Amp. ) of the propeller deice ammeter pointer indicates normal operation of the deicing elements of first one propeller and then the other.

To check all the heating elements of both propellers and the deice timer for normal operation, the system must be left ON for approximately two and one-half minutes.

The timer directs current to the propeller boots in cycles between boot elements and between propellers in the following cycling sequence:

- Heating Period No. 1 - Outboard halves - right engine blades.
- Heating Period No. 2 - Inboard halves - right engine blades.
- Heating Period No. 3 - Outboard halves - left engine blades.
- Heating Period No. 4 - Inboard halves - left engine blades.

Each heating period lasts for approximately one-half minute.

### EMERGENCY OPERATION

Abnormal operation of the propeller deice system is indicated by the propeller deice switch breaker tripping to the OFF position. Failure of the switch breaker to stay reset indicates that deicing is impossible for the propellers.

A reading below 8 Amp. (2 bladed) and 12 Amp. (3 bladed) on the propeller deice ammeter indicates that the blades of the propeller are not being deiced uniformly.

### WARNING

When uneven deicing of the propeller blades is indicated, it is imperative that the deicing system be turned OFF. Uneven deicing of the blades can result in propeller unbalance and engine failure.

## DEICE BOOT SYSTEM

### OPERATING CHECKLIST

#### Before Entering Aircraft

- (1) During the exterior inspection, check the boots for tears, abrasions, and cleanliness. Have boots cleaned and any major damage repaired before takeoff.

#### During Engine Runup

- (1) Position deice switch to ACTUATE and check inflation and deflation cycles. The pressure indicator light (amber in color) should light when the system reaches 10 PSI. The system may be recycled as soon as the light goes OFF, or as required.

### NOTE

The deice system is manually controlled. Every time a deicing cycle is desired, the switch must be positioned to ACTUATE. The switch will instantly spring back to OFF, but a 6 second delay action in the timing relay will complete the deicing inflation cycle.

- (2) Check boots visually for complete deflation to the vacuum hold-down position.

#### NOTE

Complete inflation and deflation cycle will last approximately 30 seconds.

#### In Flight

- (1) When ice has accumulated to approximately 1/2 inch thick on the leading edges, position deice switch to ACTUATE.

#### After Landing

- (1) Check boots for damage and cleanliness. Remove any accumulations of engine oil or grease.

#### OPERATING DETAILS

Cycling the deice boots produces no adverse aerodynamic effects in any attitude within the allowable flight limitations.

Deice boots are intended to remove ice after it has accumulated rather than preventing its formation. If the rate of ice accumulation is slow, best results can be obtained by leaving the deice system OFF until 1/4 to 3/4 inch of ice has accumulated. After clearing this accumulation with one or two cycles of operation, the system should remain OFF until a significant quantity of ice has again accumulated. Rapid cycling of the system is not recommended, as this may cause the ice to grow outside the contour of the inflated boots, preventing its removal.

#### NOTE

Since wing and horizontal stabilizer deice boots alone do not provide adequate protection for the entire aircraft, known icing conditions should be avoided whenever possible. If icing is encountered close attention should be given to the pitot-static system, propellers, induction systems, and other components subject to icing.

The deice system will operate satisfactorily on either or both engines. During single-engine operation, suction to the gyros will drop momentarily during the boot inflation cycle.

## **DEICE BOOT CARE**

Deice boots have a special, electrically-conductive coating to bleed off static charges which cause radio interference and may perforate the boots. Fueling and other servicing operations should be done carefully, to avoid damaging this conductive coat or tearing the boots.

Keep the boots clean and free from oil and grease, which swell the rubber. Wash the boots with mild soap and water, using benzol or unleaded gasoline, if necessary, to remove stubborn grease. Do not scrub the boots and be sure to wipe off all solvent before it dries.

Small tears and abrasions can be repaired temporarily without removing the boots and the conductive coating can be renewed. Your Cessna Dealer has the proper materials and know-how to do this correctly.

## **ALCOHOL WINDSHIELD DEICE SYSTEM**

The alcohol windshield deice system consists of an alcohol tank, a pump, left and right-hand dispersal tubes, and a switch breaker.

The alcohol tank, located in the aft end of the right wing locker, has a 3.0 gallon capacity. The tank should be filled with isopropyl alcohol only. Water dilution of the alcohol is not recommended, as any water contained in the alcohol will reduce the efficiency of ice removal and may freeze on the windshield at very low temperatures. The pump located adjacent to the tank provides positive pressure to the windshield dispersal tubes. The left and right-hand dispersal tubes located at the forward base of the windshield provide flow pattern control throughout the aircraft's speed envelope. Each tube contains five holes which should be inspected and cleaned with a small diameter wire as necessary.

## **OPERATING CHECKLIST**

### **Before Entering Aircraft**

- (1) During the exterior inspection, check the windshield dispersal tubes for cleanliness. Check the tank alcohol level. Flow requirements are 3.0 gallons per hour of continuous operation.

### **During Engine Runup**

- (1) Position the windshield deice switch breaker to ON. Allow approximately 10 seconds for flow to begin. Assure that each of the five holes in left and right-hand dispersal tubes are flowing alcohol. Return the windshield deice switch breaker to the OFF position.

### **Normal Operation**

To operate the windshield deice system, proceed as follows:

- (1) Windshield Deice Switch Breaker - ON.

#### **NOTE**

Allow approximately 1/8 to 1/4 inch of ice to accumulate. The windshield deice system can be used as an anti-ice system by continuous use. However, the maximum endurance with a 3-gallon tank is approximately 1.0 hour of continuous operation. Airspeed should be 160 MPH IAS or below for best results.

- (2) Windshield - CHECK (allow approximately 10 seconds for alcohol flow to begin).
- (3) When windshield ice is removed, windshield deice switch breaker - OFF.

#### **WARNING**

The windshield deice switch breaker must be positioned OFF 20 seconds prior to reaching minimum descent altitude. The alcohol film must be allowed to evaporate before a clear field of vision through the windshield is available.

## Emergency Operation

Abnormal operation of the alcohol windshield deice system is indicated by the switch breaker tripping to the OFF position or failure of alcohol to flow onto the windshield. Do not leave system on more than 3 minutes without alcohol flow.

## PROPELLER SYNCHRONIZER

The propeller synchronizer matches propeller RPM of the two engines on the aircraft. The propeller RPM of the slave (right) engine will follow changes in RPM of the master (left) engine over a limited range. This limited range feature prevents the slave engine losing more than a fixed amount of propeller RPM in case the master engine is feathered with the synchronizer ON. The synchronizer switch in the OFF position will automatically actuate the synchronizer to the center of its range before stopping, to insure that the control will function normally when next turned on. The system indicator light should light when the synchronizer switch is in the ON position.

In addition to maintaining propeller synchronization and elimination of the unpleasant audio beat accompanying unsynchronized operation, the propeller synchronizer can also provide a significant reduction in cabin vibration by maintaining an optimum angular or phase relationship between the two propellers.

With the propeller slightly out of synchronization so that an audio beat is obtained approximately once each 5 seconds, it should be noted that the vibration level of the cabin and instrument panel will increase and decrease at a rate of approximately once each 20 seconds. Optimum operation will be obtained by manually synchronizing the propellers and engaging the synchronizer during the period of minimum vibration. The angular relationship of the propellers should be maintained for extended periods of time unless disturbed by moderate atmospheric turbulence.



#### NOTE

- Manually synchronize and phase the engines prior to switching the propeller synchronizer system ON.
- The propeller synchronizer must be switched OFF during takeoff, landing and single-engine operation.

## ECONOMY MIXTURE INDICATOR

The Cessna Economy Mixture Indicator is an exhaust gas temperature sensing device which is used to aid the pilot in selecting the most desirable fuel-air mixture for cruising flight at less than 75% power. Exhaust gas temperature (EGT) varies with the ratio of fuel-to-air mixture entering the engine cylinders.

### OPERATING INSTRUCTIONS

- (1) In takeoff and full power climb, lean the mixture as indicated by the white or blue markings on the fuel flow indicator.

#### NOTE

Leaning in accordance with markings on the fuel flow indicator will provide sufficiently rich mixture for engine cooling. Leaner mixtures are not recommended for power settings in excess of 75%.

- (2) In level flight (or cruising climb at less than 75% power), lean the mixture to peak EGT, then enrichen as desired using Figure 7-3 as a guide.

### NOTE

- Changes in altitude, OAT or power settings require the EGT to be rechecked and the mixture reset.
- Operation at peak EGT is not authorized for normal continuous operation, except to establish peak EGT for reference. Operating leaner than peak EGT minus 25° F (enrichen) is not approved.

- (3) Use rich mixture (or mixture appropriate for field elevation) in idle descents or landing approaches. Leaning technique for cruise descents may be with EGT reference method (at least every 5000 feet) or by simply enriching to avoid engine roughness, if numerous power reductions are made.

MIXTURE DESCRIPTION	EXHAUST GAS TEMPERATURE	TAS LOSS FROM BEST POWER	RANGE INCREASE FROM BEST POWER
<b>BEST POWER</b> (Maximum Speed)	Peak Minus 75° F (enrichen)	0 MPH	0%
<b>RECOMMENDED LEAN</b> (Owners Manual & Computer Performance)	Peak Minus 25° F (enrichen)	2 MPH	10%

Figure 7-3

## ELECTRIC ELEVATOR TRIM

The electric elevator trim system consists of an electrically operated drive motor and clutch assembly, which receives power through a momentary ON two way switch and an emergency disengage switch.

## **NORMAL OPERATION**

To operate the electric elevator trim system proceed as follows:

- (1) Battery Switch - ON.
- (2) Elevator Trim Disengage Switch - ELEVATOR TRIM.
- (3) Trim Switch - ACTUATE (AS DESIRED).
- (4) Elevator Position Indicator - CHECK.

### **NOTE**

To check the operation of the disengage switch, actuate the elevator trim switch with the disengage switch in the disengage position. Observe that the manual trim wheel and indicator do not rotate when the elevator trim switch is actuated.

## **EMERGENCY OPERATION**

Electric Elevator Trim System Failure

- (1) Elevator Trim Disengage Switch - DISENGAGE.

### **NOTE**

The disengage switch removes all power from the system and places motor and clutch circuits to ground.

- (2) Manual Trim - AS REQUIRED.

## DUAL HEATED PITOT SYSTEM

The dual heated pitot airspeed system consists of two pitot heads manifolded together and located on the sides of the fuselage just forward of the pilot's compartment.

### WITHOUT WEATHER RADAR INSTALLED

When the system is installed without the radar nose, the standard pitot head remains in the normal position and indicates on the pilot's airspeed indicator in the normal manner (See Pilot's Checklist for airspeed calibrations). The dual pitot system indicates on the copilot's airspeed indicator. The following tables present the copilot's airspeed calibrations.

NORMAL STATIC SOURCE						
AIRSPEED CORRECTION TABLE						
Gear Position Flap Position MPH-CAS	Up 0° MPH-IAS	Down 15° MPH-IAS	Down 35° MPH-IAS			
80	74	67	73			
100	98	95.5	98			
120	119	118	119.5			
140	138.5	138.5	140			
160	158.5	159	160			
180	178.5	179.5				
200	198.5					
220	218					
240	238					
ALTERNATE STATIC SOURCE AIRSPEED CALIBRATIONS						
Pilot's Storm Window Closed Heater Vents "on" or "off"				Pilot's Storm Window Open Heater Vents "on" or "off"		
Gear Position Flap Position MPH-CAS	Up 0° MPH-IAS	Down 15° MPH-IAS	Down 35° MPH-IAS	Up 0° MPH-IAS	Down 15° MPH-IAS	Down 35° MPH-IAS
80	72	68	74.5	86.5	82	89
100	97.5	98.5	101	112	112	115.5
120	120	123.5	123.5	135	136	137.5
140	141.5	146	145.5	156	157.5	159.5
160	163	169	167	177.5	180	181
180	184.5	191.5		200	202	
200	206.5			221.5		
220	227.5			243		
240	248.8			264.5		

Figure 7-4

## WITH WEATHER RADAR INSTALLED

When the optional weather radar is installed, the standard pitot head is deleted and only the two side pitot heads are installed. In this configuration both the pilot and copilot's airspeed indicators are connected to the optional pitot heads. The airspeed calibrations with this configuration are shown in the following tables.

NORMAL STATIC SOURCE						
AIRSPEED CORRECTION TABLE						
Gear Position Flap Position MPH-CAS	Up 0° MPH-IAS	Down 15° MPH-IAS	Down 35° MPH-IAS			
80	69	70	73.5			
100	95.5	95.5	97.5			
120	117	117	118			
140	137.5	137.5	139			
160	157.5	158	160			
180	178	178.5				
200	198					
220	218					
240	238					
ALTERNATE STATIC SOURCE AIRSPEED CALIBRATIONS						
Pilot's Storm Window Closed Heater Vents "on" or "off"				Pilot's Storm Window Open Heater Vents "on" or "off"		
Gear Position Flap Position MPH-CAS	Up 0° MPH-IAS	Down 15° MPH-IAS	Down 35° MPH-IAS	Up 0° MPH-IAS	Down 15° MPH-IAS	Down 35° MPH-IAS
80	67	71	75	81.5	85	89.5
100	95	97.5	100.5	109.5	112	115
120	118	122.5	122	133	135	136
140	140.5	145	144.5	155	156.5	158.5
160	162	168	167	176.5	179	181
180	184	190.5		199.5	201	
200	206			221		
220	227.5			243		
240	248.8			264.5		

Figure 7-5

## **AIR CONDITIONING SYSTEM**

The optional air conditioning system, see Figure 7-6, consists of the following major components: a pair of evaporators and condensate drain lines, an electrically driven compressor and condenser module, control panel and two circuit breakers.

The control panel, located on the right instrument panel, provides two switches for the selection of the AIR CONDITIONING or VENTILATE mode and for blower speed control. As the system is electrically driven, it is important to monitor the voltmeter to prevent battery discharge.

The evaporators are located on the aft baggage shelf and direct conditioned air into the cabin. The compressor and condenser module, located in the aft cabin, liquify the Freon gas and remove the heat absorbed by the evaporators. The heat is then exhausted overboard through the underside of the fuselage. All condensation from the evaporators is drained overboard by a pair of condensate drain lines.

### **LIMITATIONS**

- (1) The aircraft must be equipped with dual 100 amp. alternators.
- (2) Air conditioning must be in the OFF or VENTILATE position for takeoff and landing.

### **NORMAL PROCEDURES**

#### **Preflight Inspection**

- (1) Inspect overboard heat and condensate drain lines for obstructions.

#### **Before Starting Engines**

- (1) Air Conditioning Switch - OFF.

## **Before Taxiing**

### **CAUTION**

During ground operation, monitor battery discharge rate by positioning voltmeter selector to BAT. Turn off nonessential electrical loads if voltmeter indicates discharge of the battery.

- (1) Air Conditioning Switch - AS DESIRED.
- (2) Blower Switch - AS DESIRED.

## **Before Takeoff**

- (1) Air Conditioning Switch - OFF or VENTILATE.

## **After Takeoff**

- (1) Air Conditioning Switch - AS DESIRED.
- (2) Blower Switch - AS DESIRED.

## **Before Landing**

- (1) Air Conditioning Switch - OFF or VENTILATE.

## **After Landing**

### **CAUTION**

During ground operation, monitor battery discharge rate by positioning voltmeter selector to BAT. Turn off nonessential electrical loads if voltmeter indicates discharge of the battery.

- (1) Air Conditioning Switch - AS DESIRED.
- (2) Blower Switch - AS DESIRED.

## EMERGENCY PROCEDURES

### Engine Inoperative Procedures

- (1) Air Conditioning Switch - OFF or VENTILATE.

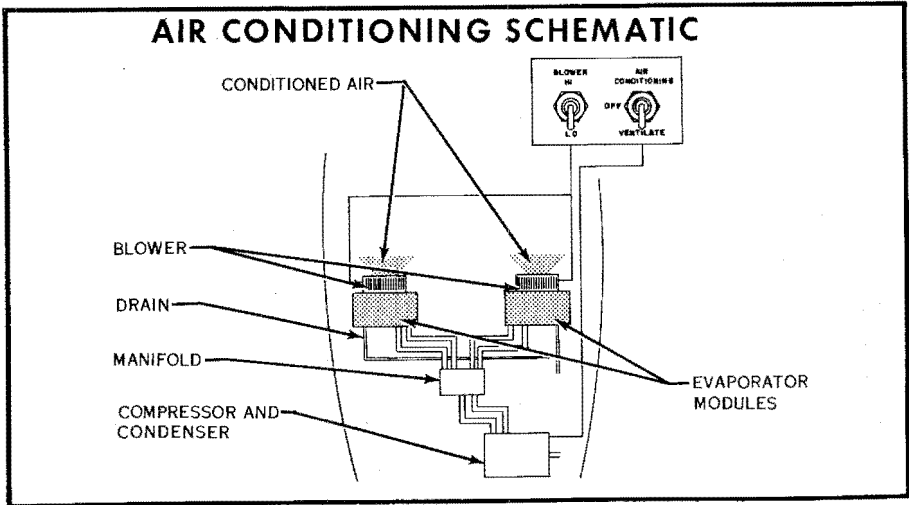

Figure 7-6

## FIRE DETECTION AND EXTINGUISHING SYSTEM

The fire detection and extinguishing system consists of three major components: three heat sensitive detectors located in each engine accessory compartment; an annunciator and actuator panel (see Figure 7-7); and a compressed Freon single shot gas bottle in each engine accessory compartment.

A test function is provided to test the system circuitry. When the test switch is pushed all lights should illuminate, if any light fails to illuminate replace the bulb. If the green light does not illuminate after replacing the bulb, replace firing cartridge in fire extinguisher. Any other light failure, after replacing bulbs and firing cartridge, indicates malfunction in unit or associated wiring.

If an overheat condition is detected, the appropriate FIRE light will annunciate the engine to be extinguished. To activate the extinguisher,



open the guard for the appropriate engine and press the FIRE light. Freon, under pressure, will be discharged to the engine and engine accessory compartments. The amber light E (Figure 7-7) will illuminate after the extinguisher has been discharged and will continue to show empty until a new bottle is installed. The FIRE light will remain illuminated until compartment temperatures cool.

	Annunciation		
	Legend	Color	Cause of Illumination
	Fire	Red	Fire condition existing in engine compartment
	E	Amber	Fire extinguisher container empty
OK	Green	Fire cartridge and associated wiring is in operational condition	

Figure 7-7

## OPERATING CHECKLIST

### NORMAL

#### Before Takeoff

- (1) Press the test switch - all lights should illuminate.

### EMERGENCY

If a fire warning light indicates an engine compartment fire and is confirmed or if a fire is observed without a fire warning light:

- (1) Shut down the appropriate engine as follows:
  - (a) Mixture control - IDLE CUT-OFF.
  - (b) Propeller - FEATHER.
  - (c) Magnetos - OFF.
  - (d) Fuel selector - OFF.
- (2) Open the appropriate guard and push FIRE light.
- (3) Land as soon as practical.

### NOTE

Better results may be obtained if the airflow through the nacelle is reduced by slowing the aircraft (as slow as practical) prior to actuating the extinguisher.

## SERVICING

The system should be checked each 100 hours or annual inspection whichever occurs first.

Check the pressure gage on each bottle to ensure the following pressures:

Temp F°	-60	-40	-20	0	+20	+40	+60	+80	+100	+120
Gage	110	127	148	174	207	249	304	367	442	532
Actual	134	155	180	212	251	299	354	417	492	582

If these pressures are not indicated, have the bottle serviced.

## LOCATOR BEACON (Model SHARC-7)

The locator beacon system is a sweep tone emergency radio transmitter incorporating an externally mounted whip antenna and a transmitter with an integral three position switch, all located on the left side of the fuselage tailcone. The switch can be reached by removing the plug button located adjacent to the locator beacon placard. Normally, the switch is in the ARM (AUTOMATIC "G" OPERATION) position; this position allows the transmitter to be activated automatically by the "G" switch. The ON (EMERGENCY & TEST) position should be used only to test the equipment or whenever a rescue is desired. The OFF (AFTER RESCUE) position should be used only after the rescue as this position will disable all emergency transmissions.

The locator beacon transmits on both UHF and VHF emergency frequencies simultaneously.

#### NOTE

The battery pack should be changed on an annual basis.

### NORMAL PROCEDURES

- (1) Antenna - CHECK (during preflight inspection).
- (2) Locator Beacon Switch - ARM (for all flight operations).

### EMERGENCY PROCEDURES

#### Before Landing

- (1) If time permits, use aircraft radio (121.5 MHz) to transmit distress call; include aircraft position if possible.

#### After Landing

- (1) Plug Button - REMOVE (located on left side of tailcone).
- (2) Locator Beacon Switch - ON.

#### After Rescue

- (1) Locator Beacon Switch - OFF.

## MANUAL AND ELECTRICAL ADJUSTABLE SEATS

The optional manually or electrically adjustable pilot's and copilot's seats are available to add to your flying comfort. Either of these seats may be adjusted fore and aft or vertically, and tilted to any desired position, within the limits of the seat.

## MANUALLY ADJUSTED SEAT CONTROLS

Controls for the optional manually adjustable seats are located at the front of the seat. Rotating the handcrank (1, Figure 7-8) at the forward right-hand corner of the seat, tilts the back. Rotating the handcrank (2, Figure 7-8) at the forward left-hand corner of the seat, raises and lowers the seat. The fore and aft adjustment lever (3, Figure 7-8) is located at the forward side of the seat near the center. It is recommended that the seat be moved to the aft position prior to making tilt or vertical adjustments, to provide maximum handcrank clearance.

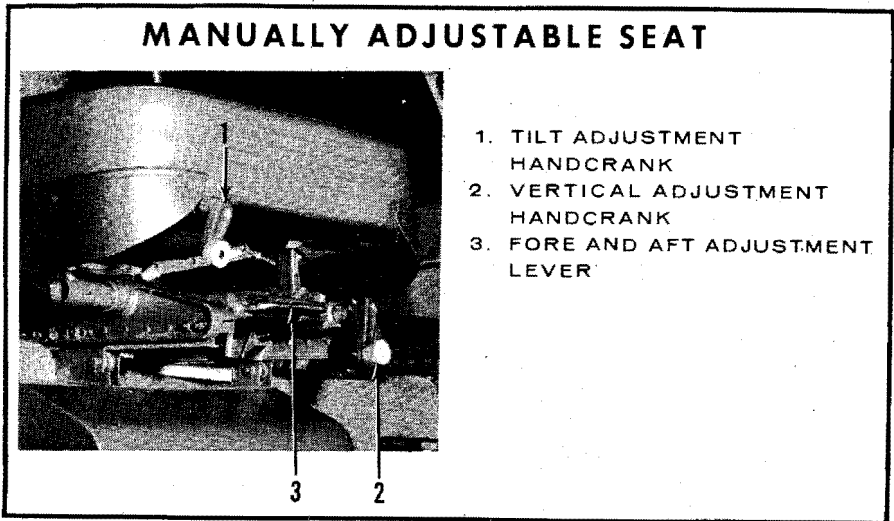

Figure 7-8

## ELECTRICALLY ADJUSTED SEAT CONTROLS

Controls for the optional electrically adjustable seats are located at the forward side of the seat at the left-hand corner. Activating the left-hand switch (1, Figure 7-9), tilts the back. Activating the right-hand switch (2, Figure 7-9), raises and lowers the seat. The fore and aft adjustment lever (3, Figure 7-9) is located at the forward side of the seat near the center. Both engines should be started prior to making tilt or vertical adjustments to the seats to preclude excessive battery drain.

### NOTE

It is recommended that the loads on seat backs and bottoms be partially relieved while making vertical or tilt adjustments.

## ELECTRICALLY ADJUSTABLE SEAT

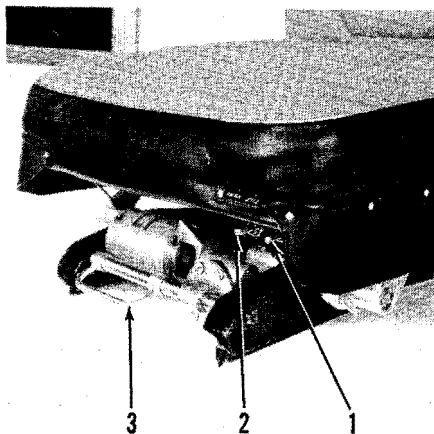

1. TILT ACTIVATION SWITCH
2. VERTICAL ACTIVATION SWITCH
3. FORE AND AFT ADJUSTMENT LEVER

Figure 7-9

## STROBE LIGHTS

The optional high intensity strobe lights will enhance anti-collision protection. However, the lights should be turned off when taxiing in the vicinity of other aircraft, or during flight through clouds, fog or haze.

*Notes* .....

<b>A</b>			
Accelerate Stop Distance	6-4	Before Takeoff	1-7, 2-4
After Landing	1-12, 2-12	Breakers, Circuit	2-21
After Takeoff	2-7		
Air Conditioning System	7-18	<b>C</b>	
Emergency Procedures	7-20	Cabin	
Limitations	7-18	Air Knob	2-27
Normal Procedures	7-18	Air Knob, Forward	2-27
Aircraft, Secure	1-12	Air Temperature Control Knob	2-26
Aircraft File	5-7	Heat Registers	2-27
Air Inlet or Filter Icing	3-16	Heat Switch	2-26
Airspeed		Care of the Aircraft	5-1
Correction Table	6-2	Deicer Boot	7-10
Indicator Instrument		Ground Handling	5-1
Markings	4-2	Interior	5-3
Limitations	4-2	Inspection Service and Inspection Periods	5-5
Nomenclature		Lubrication and Servicing Procedures	5-8
Multi-Engine	2-6	Mooring Your Aircraft	5-2
Single-Engine	3-2	Painted Surfaces	5-3
Summary	6-1	Propeller	5-3
Alternate Induction Air System	2-9	Windows and Windshield	5-2
Alternator Failure	3-13	Charts	
Authorized, Operations	4-1	Accelerate Stop Distance	6-4
Auxiliary Fuel Pump		Airspeed	
Switches	2-17	Correction Table	6-2
Auxiliary Fuel System	7-1	Nomenclature Summary	6-1
		Cargo Loading	4-6
<b>B</b>		Center of Gravity Moment Envelope	4-7
Balance, Weight and	4-4	Climb Performance	
Battery and Alternator		Multi-Engine Cruise	6-6
Switches	2-21	Multi-Engine Maximum	6-6
Beacon, Locator	7-22	Single-Engine	6-7
Beacon, Rotating	2-22	Cruise Performance at	
Before Landing	1-11, 2-11	2500 Feet	6-8
Before Starting Engines	1-1	5000 Feet	6-8

7500 Feet . . . . .	6-9
15,000 Feet . . . . .	6-10
Landing Performance . . . . .	6-12
Loading . . . . .	4-6
Maximum Glide . . . . .	3-10
Mixture Indicator, Economy . . . . .	7-13
Normal Takeoff Distance . . . . .	6-3
Oxygen Duration Chart . . . . .	7-3
Oxygen Servicing . . . . .	7-5
Range Profile . . . . .	6-11
RPM To Simulate Critical (Left) Engine Inoperative and Feathered . . . . .	3-5
Stall Speed . . . . .	6-2
Single-Engine Climb Data . . . . .	6-7
Service Ceiling . . . . .	6-7
Takeoff Distance . . . . .	6-5
Checklist, Operating . . . . .	1-1
Deice Boot System . . . . .	7-8
Circuit Breakers . . . . .	2-21
Climb . . . . .	1-9, 2-7
Maximum Performance . . . . .	2-10
Normal . . . . .	1-9
Cold Weather Equipment . . . . .	7-6
Cold Weather Operation . . . . .	2-14
Console, Overhead . . . . .	2-30
Contents, Table of . . . . .	iii
Cruise . . . . .	2-8
Cruising . . . . .	1-10
Cylinder Head Temperature . . . . .	4-3

## D

Defrost Knob . . . . .	2-27
Defrosting, and Heating . . . . .	2-26
Deice, Alcohol Windshield . . . . .	7-10
Operating Checklist . . . . .	7-11
Deice Boot Care . . . . .	7-10
Deice Boot System . . . . .	7-8
Operating Checklist . . . . .	7-8
Operating Details . . . . .	7-9

Description and Operating Details . . . . .	2-1
Dimensions, Principle . . . . .	ii
Ditching . . . . .	3-20
Dual Heated Pitot System . . . . .	7-16

## E

Economy Mixture Indicator . . . . .	7-13
Electric Elevator Trim . . . . .	7-14
Electrical-Power Distribution Schematic . . . . .	2-20
Electric Gyro . . . . .	3-15
Electric System . . . . .	2-19, 3-13
Elevator Trim, Electric . . . . .	7-14
Emergencies Ditching . . . . .	3-20
Electrical System . . . . .	3-13
Emergency Exit . . . . .	2-30
Emergency Power Switch . . . . .	2-21
Engine Inoperative Procedures After Takeoff . . . . .	3-1
During Flight . . . . .	3-6
During Takeoff . . . . .	3-1
Restarts in Flight . . . . .	3-8
Supplementary Information . . . . .	3-2
Flight Instruments . . . . .	3-14
Fuel System . . . . .	3-12
Landing Defective Gear Main . . . . .	3-17
Nose . . . . .	3-19
Flat Tire Main Gear . . . . .	3-17
Nose Gear . . . . .	3-19
Gear Will Not Extend Electrically . . . . .	3-15
Retract Electrically . . . . .	3-16
Procedures . . . . .	3-1
Engine Fire Procedures . . . . .	3-7



Operation Limitations . . . . .	4-2	Schematic . . . . .	2-15
Restarts In Flight . . . . .	3-8	Wing Locker . . . . .	7-2
Engine Failure			
After Takeoff . . . . .	3-1		
During Flight . . . . .	3-6		
During Takeoff,		<b>G</b>	
Supplementary		Gages	
Information . . . . .	3-2	Fuel Flow . . . . .	2-17
During Takeoff . . . . .	3-1	Oil Pressure . . . . .	4-2
Engine Instruments		Oil Temperature . . . . .	4-2
Cylinder Head Temperature	4-3	Glide, Maximum . . . . .	3-10
Fuel Flow . . . . .	2-17, 4-3	Go-Around, Single-Engine.	3-12
Manifold Pressure . . . . .	4-3	Go-Around, Multi-Engine .	1-12
Markings . . . . .	4-2	Ground Handling . . . . .	5-1
Oil Pressure . . . . .	4-2	Gyro, Electric . . . . .	3-15
Oil Temperature . . . . .	4-2		
Tachometer . . . . .	4-3		
Engines, Starting	2-2	<b>H</b>	
Before Starting . . . . .	1-1	Handcrank, Landing	
Starting, Left Engine		Gear . . . . .	2-23, 2-24
First . . . . .	1-4, 1-6	Handling, Ground . . . . .	5-1
External Power Source,		Heater Operation for	
Starting . . . . .	1-4, 1-6	Heating and Defrosting . . . . .	2-26
<b>F</b>		Heater Used for Ventilation	2-28
File, Aircraft . . . . .	5-7	Heating, Ventilating and	
Fire Detection and		Defrosting System . . . . .	2-24, 2-25
Extinguishing System . . . . .	7-20		
Fire Engine Procedure . . . . .	3-7	<b>I</b>	
Flight Instruments . . . . .	3-14		
Flyable Storage . . . . .	5-4	Icing, or Obstruction of	
Forced Landing		Static Source . . . . .	3-14
Complete Power Loss . . . . .	3-11	Induction Air System	
Precautionary Landing		Alternate . . . . .	2-9, 3-16
With Power . . . . .	3-10	Inspection, Preflight . . . . .	1-2, 2-1
Fuel		Inspection, Service and	
Flow . . . . .	4-3	Inspection Periods . . . . .	5-5
Flow Gage . . . . .	2-18	Instrument Markings,	
Management . . . . .	2-18	Engine . . . . .	4-2
Pump Switches, Auxiliary	2-17	Cylinder Head	
Selector Valve Handles . . . . .	2-16	Temperature . . . . .	4-3
Quantity Indicator . . . . .	2-19	Fuel Flow . . . . .	4-3
System . . . . .	2-16		
Auxiliary . . . . .	7-1		

Manifold Pressure . . . . .	4-3
Oil Pressure . . . . .	4-2
Oil Temperature . . . . .	4-2
Tachometer . . . . .	4-3
Instrument Panel . . . . .	iv
Interior Care . . . . .	5-3

## L

Landing . . . . .	1-11, 2-11
After . . . . .	1-12, 2-12
Before . . . . .	1-11, 2-11
Emergencies . . . . .	3-17
Flat Main Gear Tire,	
Landing With . . . . .	3-17
Flat Nose Gear Tire,	
Landing With . . . . .	3-18
Forced (Complete Power	
Loss) . . . . .	3-11
Forced (Precautionary	
With Power) . . . . .	3-10
Gear Handcrank . . . . .	2-23, 2-24
Gear Position Lights . . . . .	2-23
Gear System . . . . .	2-22, 3-15
Gear Warning Horn . . . . .	2-23
Letdown . . . . .	1-11, 2-10
Limitations, Airspeed . . . . .	4-2
Loading Chart . . . . .	4-6
Locator Beacon . . . . .	7-22
Lockers, Wing . . . . .	4-3
Lubrication and Servicing	
Procedures . . . . .	5-8
Luggage Tie-Down . . . . .	4-3

## M

MAA Identification Plate . . . . .	5-1
Management, Fuel Flow . . . . .	2-18
Maneuvering Flight . . . . .	2-10
Maneuvers, Normal	
Category . . . . .	4-1
Manifold Pressure . . . . .	4-3
Manual and Electrical	

Adjustable Seats . . . . .	7-23
Maximum Glide . . . . .	3-9
Maximum Performance	
Climb . . . . .	1-10, 6-6
Maximum Performance	
Takeoff . . . . .	1-9, 6-7
Mixture Description	
Chart . . . . .	7-14
Mooring Your Aircraft . . . . .	5-2
Multi-Engine Airspeed	
Nomenclature . . . . .	2-6
Climb Data . . . . .	6-6

## N

Night Flying . . . . .	2-13
Normal Category	
Maneuvers . . . . .	4-1
Normal Climb . . . . .	1-9
Normal Start . . . . .	1-4
Normal Takeoff . . . . .	1-8
Normal Takeoff Distance	
Chart . . . . .	6-3

## O

Obstruction or Icing of	
Static Source . . . . .	3-14
Operating Checklist . . . . .	1-1
Operating Limitations . . . . .	4-1
Operation Limitations,	
Engine . . . . .	4-2
Operational Data . . . . .	6-1
Operations Authorized . . . . .	4-1
Optional Systems . . . . .	7-1
Overheat Warning Light,	
Heater . . . . .	2-28
Overhead Console . . . . .	2-30
Overvoltage Relay . . . . .	2-21
Owner Follow-Up System . . . . .	5-6
Oxygen System . . . . .	7-2
Before Flight . . . . .	7-4
Duration Chart . . . . .	7-3

During Flight . . . . .	7-4
Operation . . . . .	7-4
Servicing . . . . .	7-5

**P**

Painted Surfaces . . . . .	5-3
Panel, Instrument . . . . .	iv
Pitot, Dual Heated System . . . . .	7-15
Pitot Heat Switch . . . . .	2-29
Power Switch, Emergency . . . . .	2-21
Preflight Inspection . . . . .	1-2, 2-1
Principle Dimensions . . . . .	ii
Problem, Sample . . . . .	4-5
Propeller Care . . . . .	5-3
Propeller Deice System . . . . .	7-6
Propeller Synchronizer . . . . .	7-12
Publications . . . . .	5-6

**R**

Range Profile . . . . .	6-11
Relays Overvoltage . . . . .	2-21
Rotating Beacon . . . . .	2-22
RPM to Simulate Critical (Left) Engine Inoperative and Feathered . . . . .	3-5

**S**

Sample Problem . . . . .	4-5
Seats, Manual and Electrical Adjustable Adjustable . . . . .	7-23
Secure Aircraft . . . . .	1-12
Servicing Intervals Checklist . . . . .	5-9
Servicing Procedures, Lubrication and . . . . .	5-8
Single-Engine Airspeed Nomenclature . . . . .	3-2
Approach and Landing . . . . .	3-9

Climb Data . . . . .	6-7
Service Ceiling . . . . .	6-7
Takeoff . . . . .	3-3
Takeoff Distance Chart . . . . .	6-5
Spins . . . . .	2-10
Stall . . . . .	2-10
Stall Speed Chart . . . . .	6-2
Starting Engines . . . . .	2-2
Left Engine First . . . . .	1-4, 1-6
Static Pressure Alternate Source Valve . . . . .	2-29
Supplementary Information, Engine Failure During Takeoff . . . . .	3-2
Switches Air Conditioning System . . . . .	7-18
Auxiliary Fuel Pump . . . . .	2-17
Battery and Alternator . . . . .	2-21
Cabin Heat . . . . .	2-26
Emergency Power . . . . .	2-21
Pitot Heat . . . . .	2-29
Synchronizer, Propeller . . . . .	7-12

**T**

Table of Contents . . . . .	iii
Tachometer . . . . .	4-3
Takeoff . . . . .	1-8, 2-5
After . . . . .	2-7
Before . . . . .	1-7, 2-4
Maximum Performance . . . . .	1-9
Normal . . . . .	1-8, 6-3
Single-Engine . . . . .	3-3, 6-5
Taxiing . . . . .	2-4

**V**

Vacuum Pump Failure . . . . .	3-15
Ventilating System . . . . .	2-29

Ventilation, Heater	
Used For . . . .	2-29
Voltammeter . . . .	2-19

Windshield Alcohol Deice .	7-10
Operating Checklist . .	7-11
Wing Locker Fuel System .	7-2
Wing Lockers . . . .	4-3
Winterization Kit . . . .	7-6

**W**

Weight and Balance . . . .	4-4
Windows and Windshield . .	5-2

# SERVICING REQUIREMENTS

310

---

## FUEL:

AVIATION GRADE - 100/130 MINIMUM (LOW LEAD FUELS ARE APPROVED FOR USE)

CAPACITY EACH MAIN TANK -- 51 GALLONS

CAPACITY EACH AUXILIARY TANK -- 20.5 GALLONS  
(40 GAL OPTION)

CAPACITY EACH AUXILIARY TANK -- 32.0 GALLONS  
(63 GAL OPTION)

CAPACITY EACH WING LOCKER TANK -- 20.5 GALLONS

## ENGINE OIL:

AVIATION GRADE -- SAE 50 ABOVE 40°F

SAE 10W30 OR SAE 30 BELOW 40°F

(MULTI-VISCOSITY OIL WITH A RANGE OF SAE 10W30 IS RECOMMENDED FOR IMPROVED STARTING IN COLD WEATHER. DETERGENT OR DISPERSANT OIL, CONFORMING TO CONTINENTAL MOTORS SPECIFICATION MHS-24A MUST BE USED.)

CAPACITY OF EACH ENGINE SUMP -- 13 QUARTS INCLUDING 1  
QUART FOR OIL FILTER.

(DO NOT OPERATE ON LESS THAN 9 QUARTS. TO MINIMIZE LOSS OF OIL THROUGH BREATHER, FILL TO 10 QUART LEVEL FOR NORMAL FLIGHTS OF LESS THAN 3 HOURS. FOR EXTENDED FLIGHT, FILL TO CAPACITY.)

OIL FILTER ELEMENT -- C294505-0102

ENGINE BREATHER SEPARATOR ELEMENT -- 0850694-5

HYDRAULIC FLUID: MIL-H-5606A (RED)

## OXYGEN:

AVIATOR'S BREATHING OXYGEN -- MIL-O-27210

MAXIMUM PRESSURE -- 1800 PSI

## TIRE PRESSURE:

MAIN WHEELS -- 60 PSI

NOSE WHEEL -- 40 PSI

## VACUUM AIR FILTER:

ELEMENT -- STANDARD SYSTEM C294501-0103

OPTIONAL SYSTEM C294501-0203

## WINDSHIELD DEICE FLUID:

ISOPROPYL ALCOHOL - MIL-F-5566 CAPACITY - 3.0 GALLONS

# CESSNA

"TAKE YOUR CESSNA HOME  
FOR SERVICE AT THE SIGN  
OF THE CESSNA SHIELD".



**CESSNA AIRCRAFT COMPANY**  
WICHITA, KANSAS